

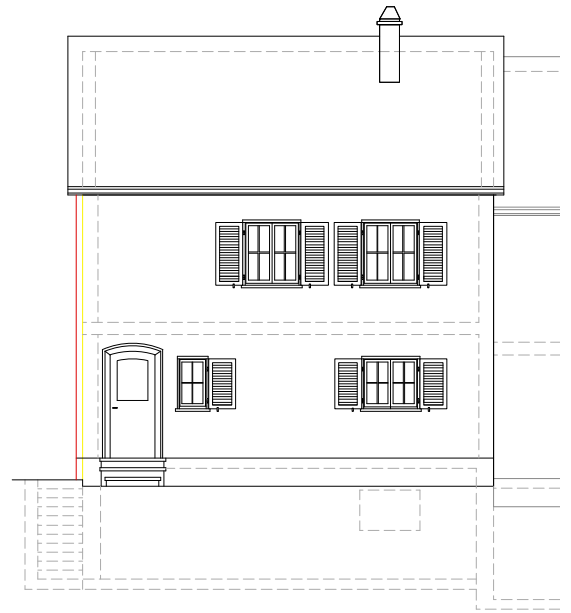

Nordostfassade bestehend

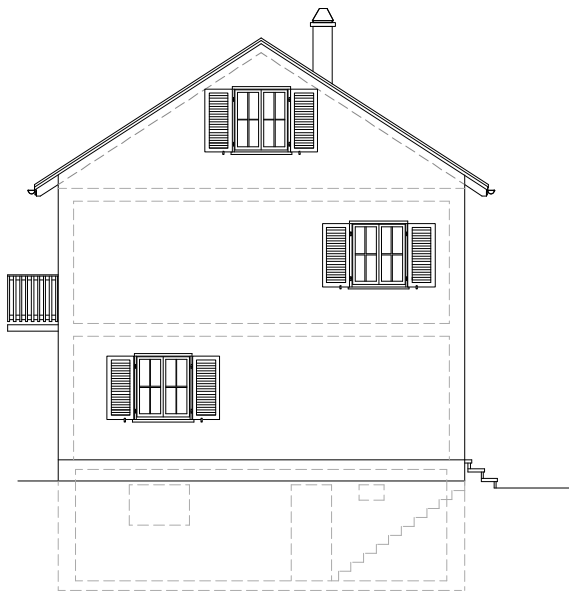

Nordostfassade saniert



Südostfassade bestehend

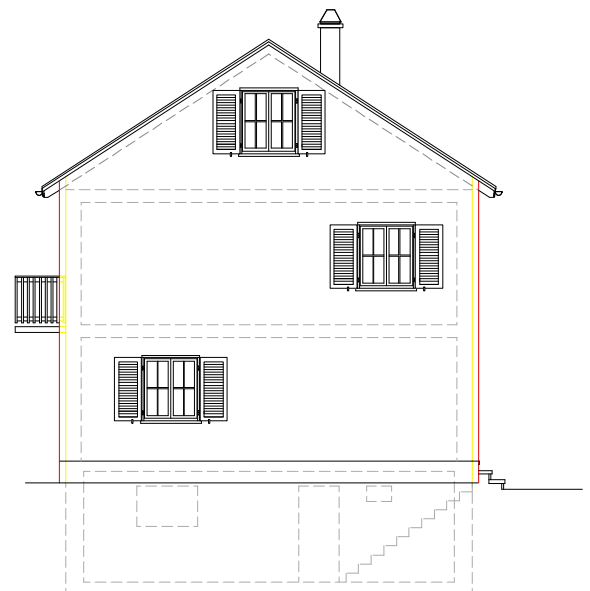

Südostfassade saniert

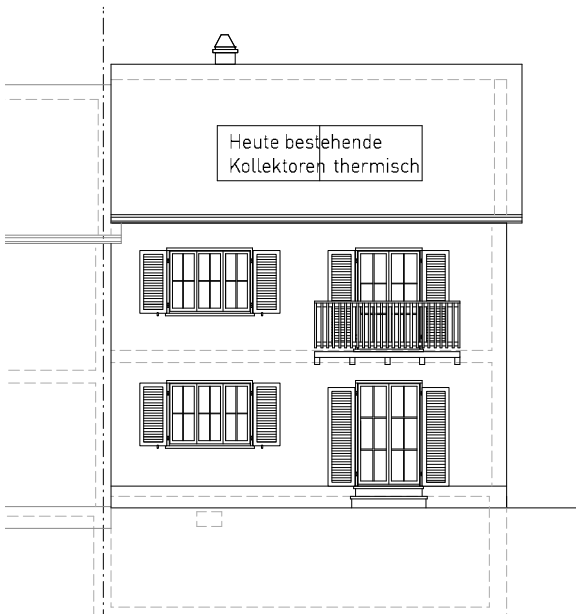

Südwestfassade bestehend

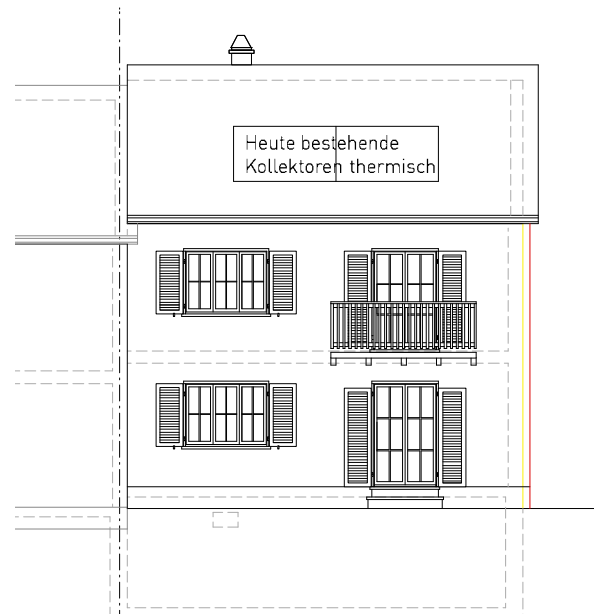

Südwestfassade saniert

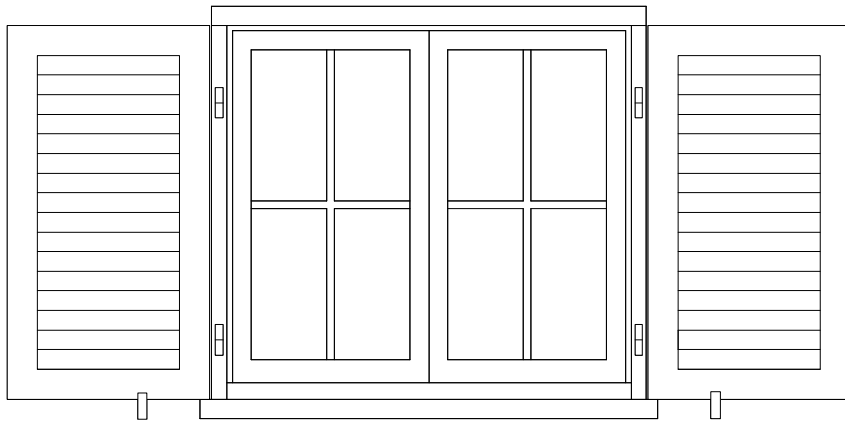
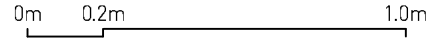

Ansicht

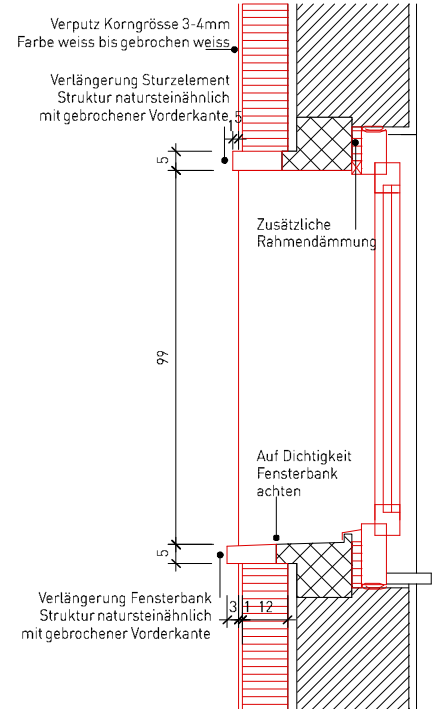

Schnitt Fenster saniert

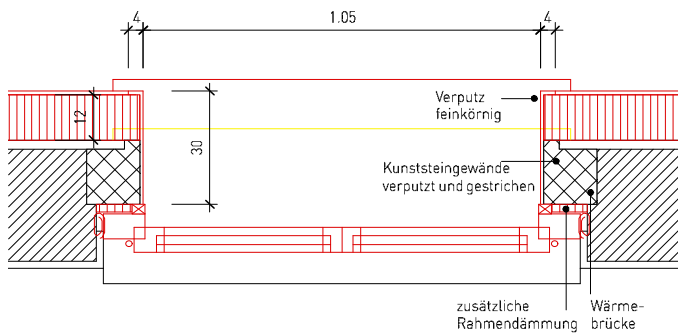

Grundriss Fenster saniert

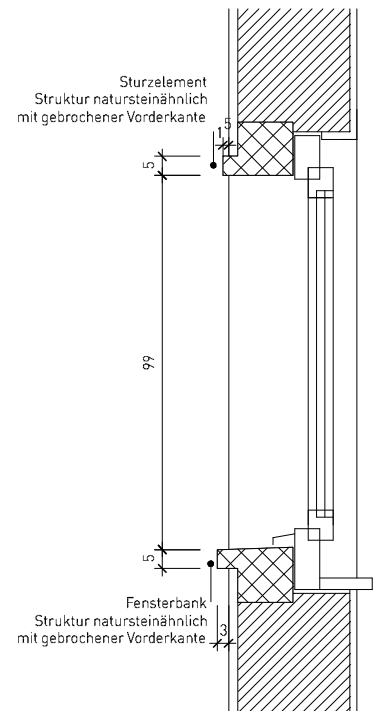

Schnitt Fenster Originalzustand

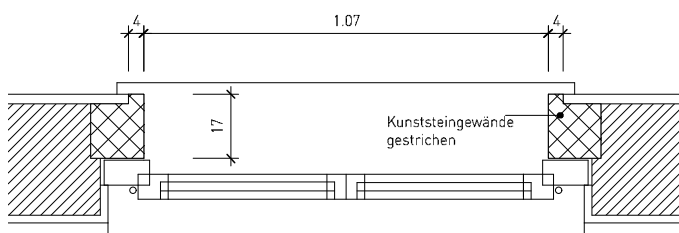

Grundriss Originalzustand

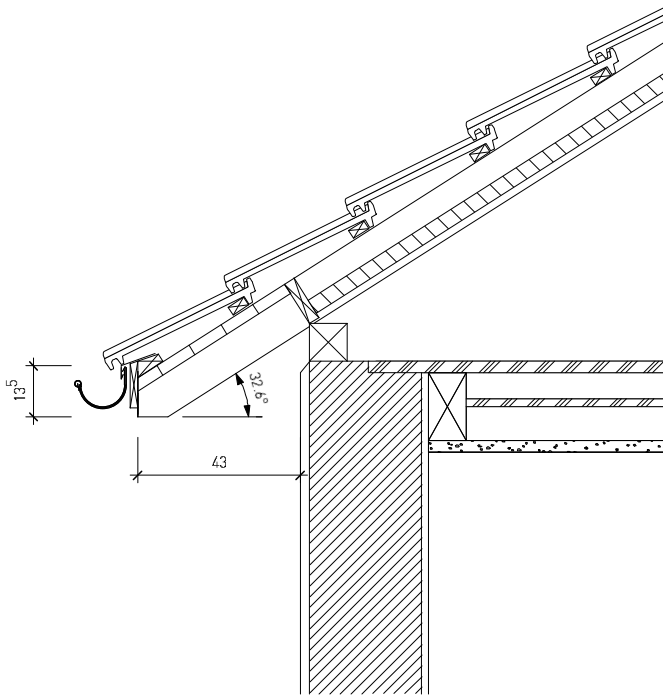
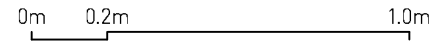

Detail Traufe Originalzustand

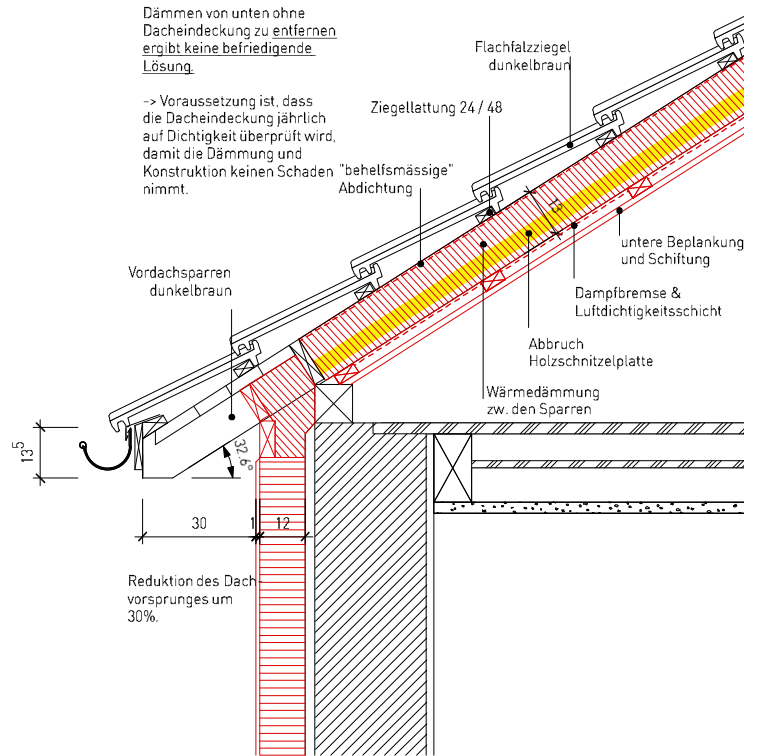

Detail Traufe saniert

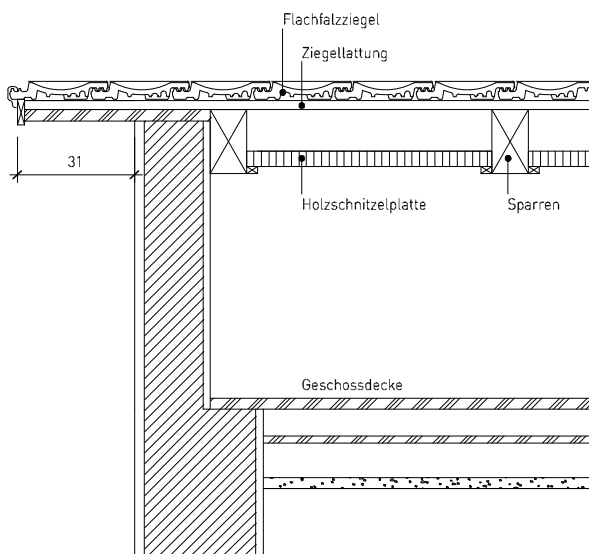

Detail Ort Originalzustand

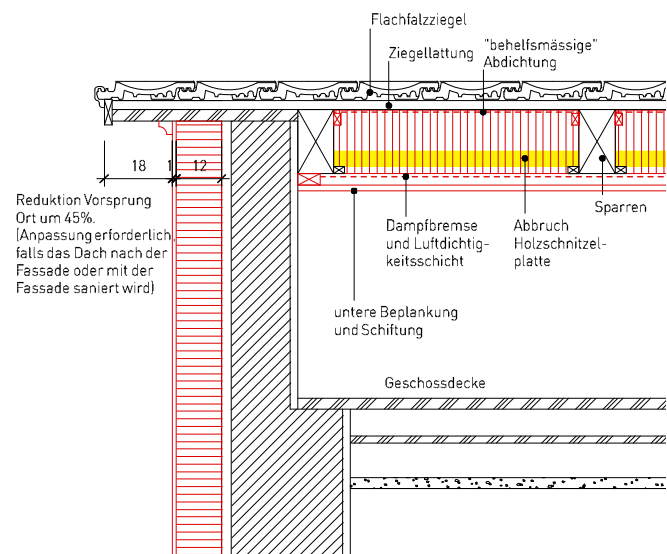

Detail Ort saniert

# Viridén + Partner Variante 2a: Energetischer Standard

## Eingangstüre (am Beispiel Haldenstrasse 34)

- Bestehend
- Neu
- Abbruch

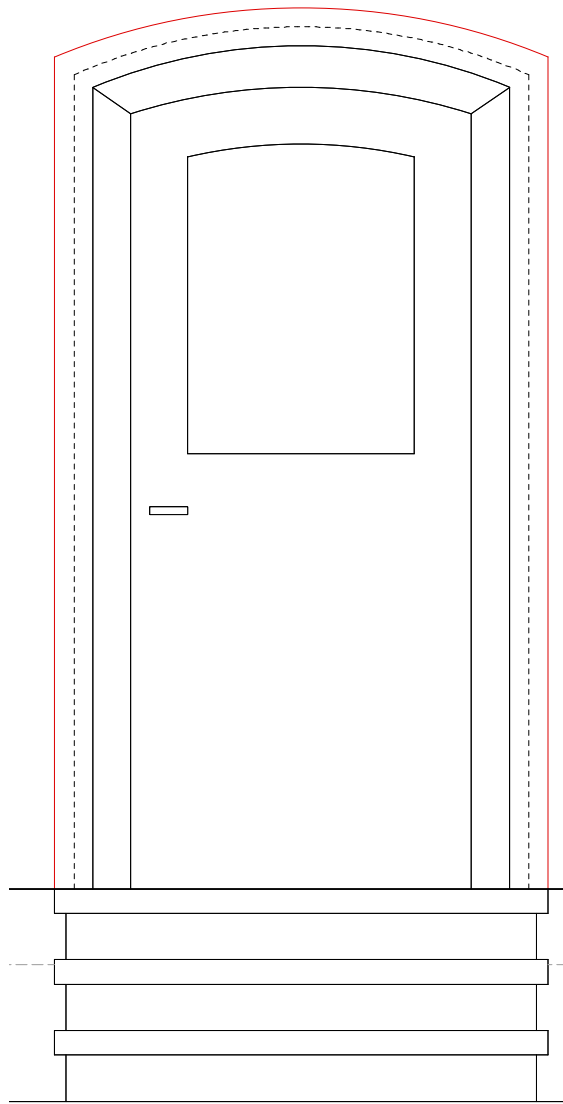

Ansicht Eingangstüre

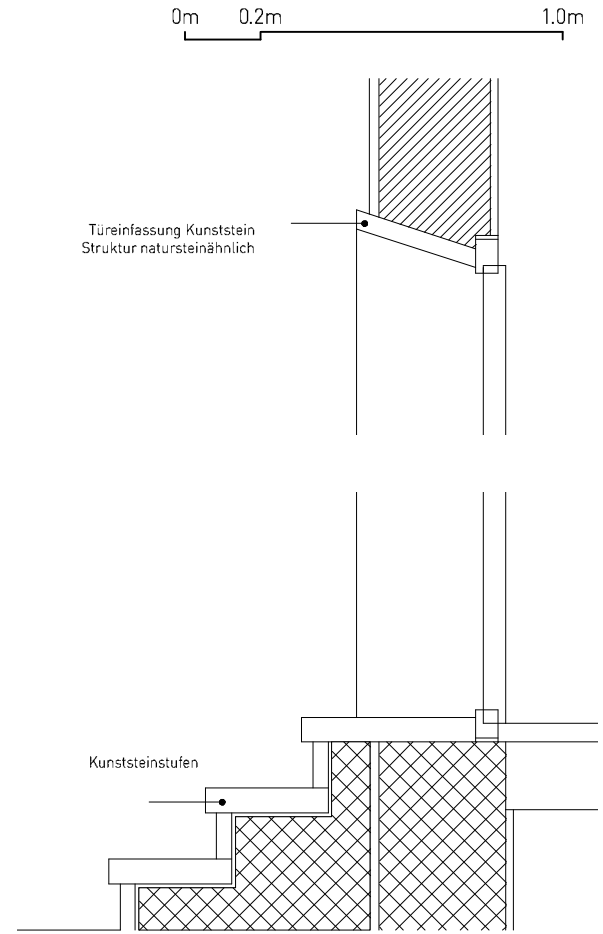

Schnitt Eingangstüre Originalzustand

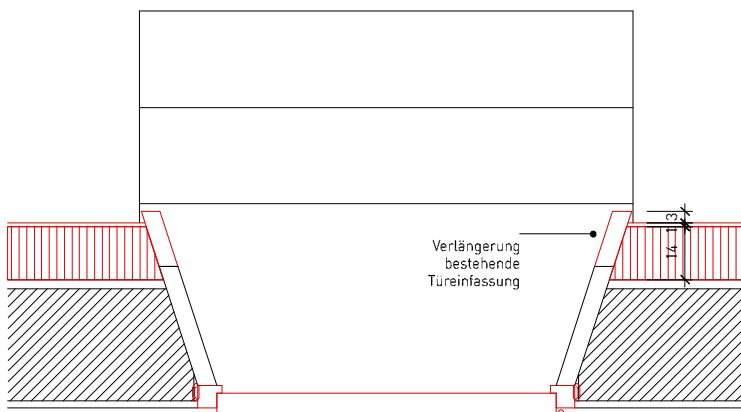

Grundriss Eingangstüre saniert

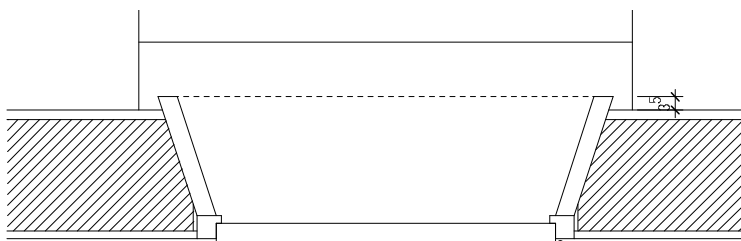

Grundriss Eingangstüre Originalzustand

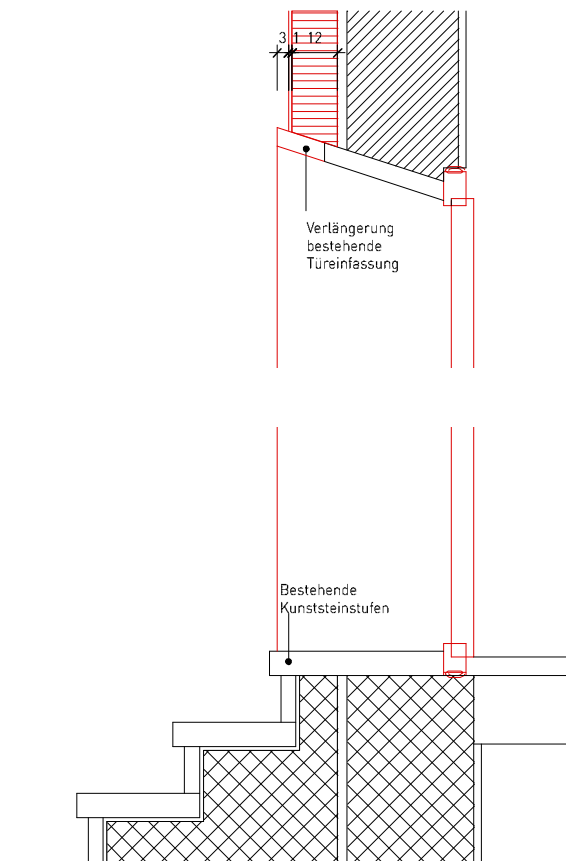

Schnitt Eingangstüre saniert

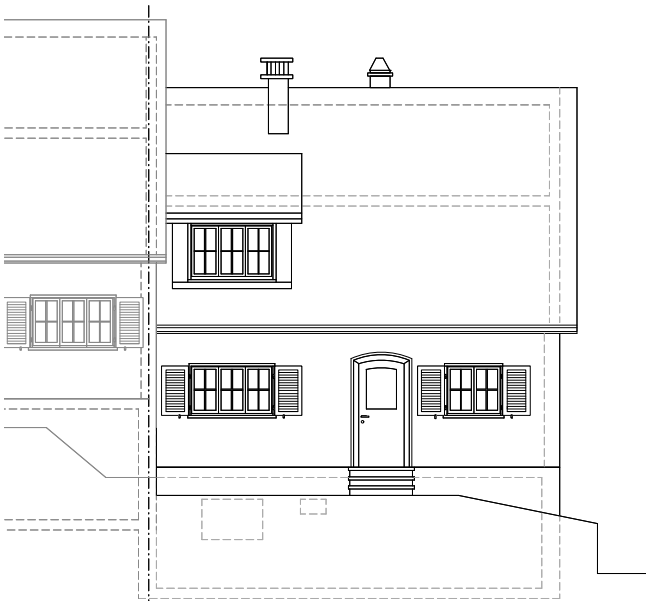

Nordostfassade bestehend

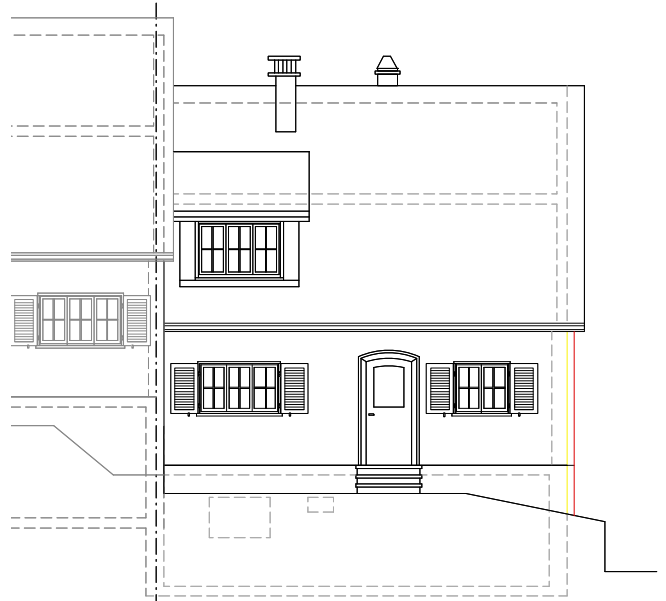

Nordostfassade saniert



Nordwestfassade bestehend



Nordwestfassade saniert

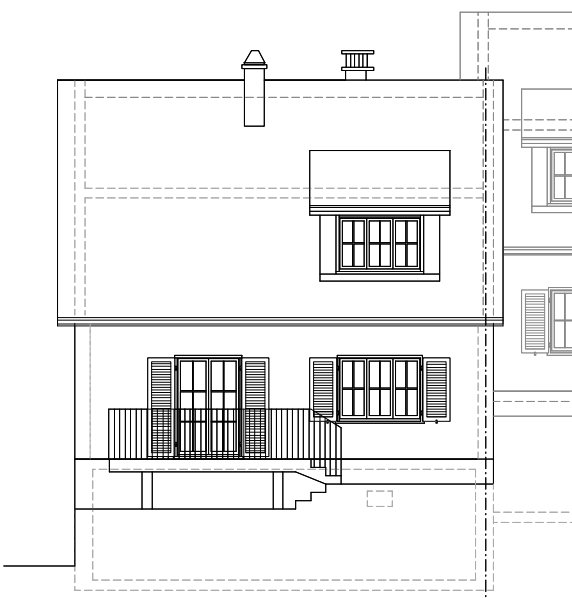

Südwestfassade bestehend

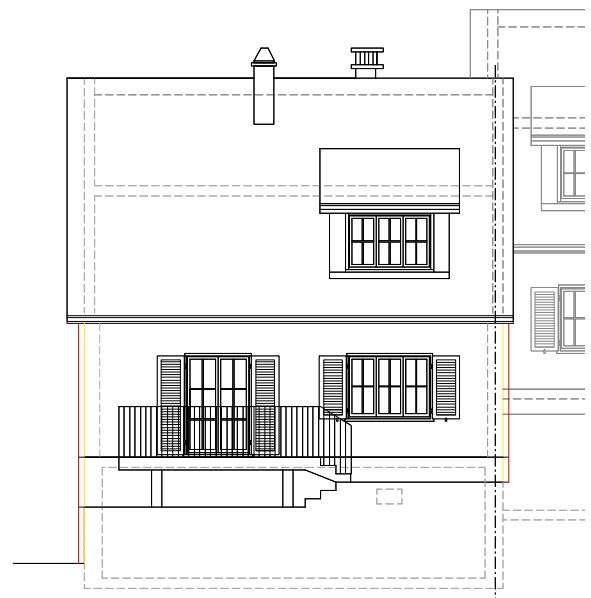

Südwestfassade saniert

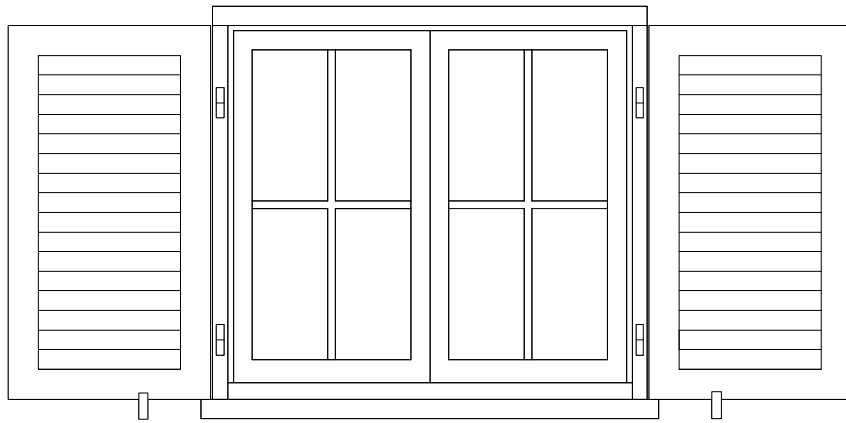
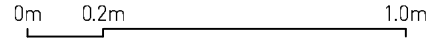

Ansicht

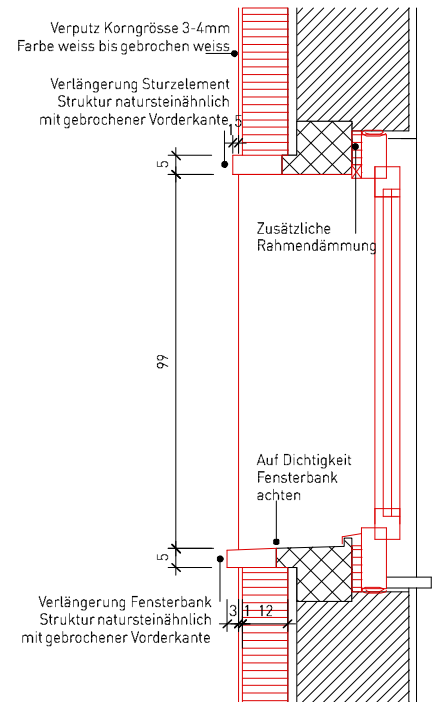

Schnitt Fenster saniert

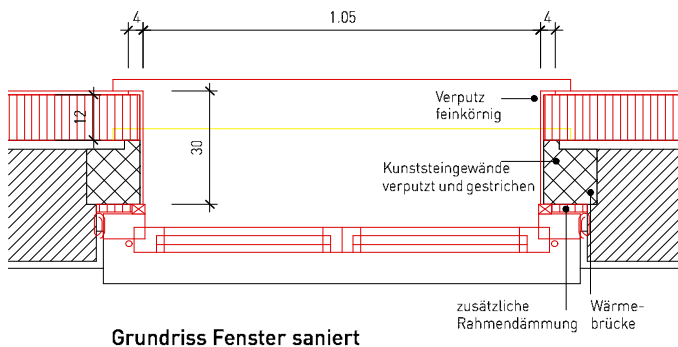

Grundriss Fenster saniert

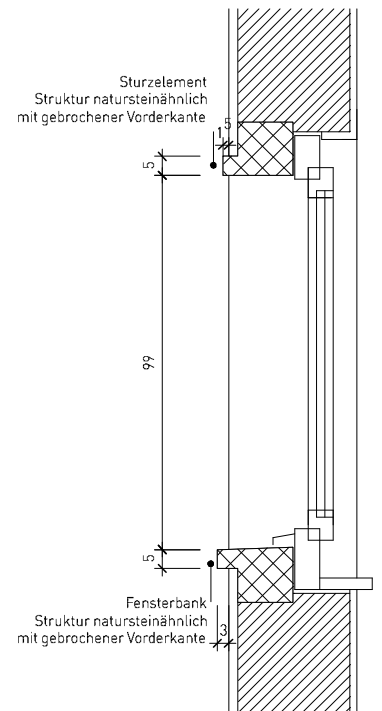

Schnitt Fenster Originalzustand

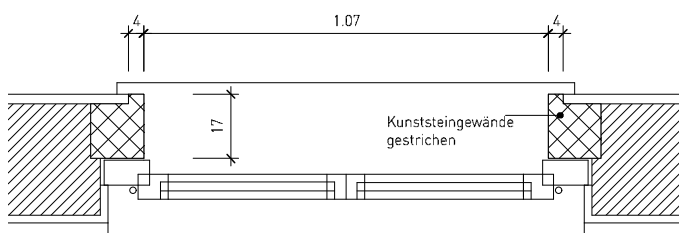

Grundriss Originalzustand

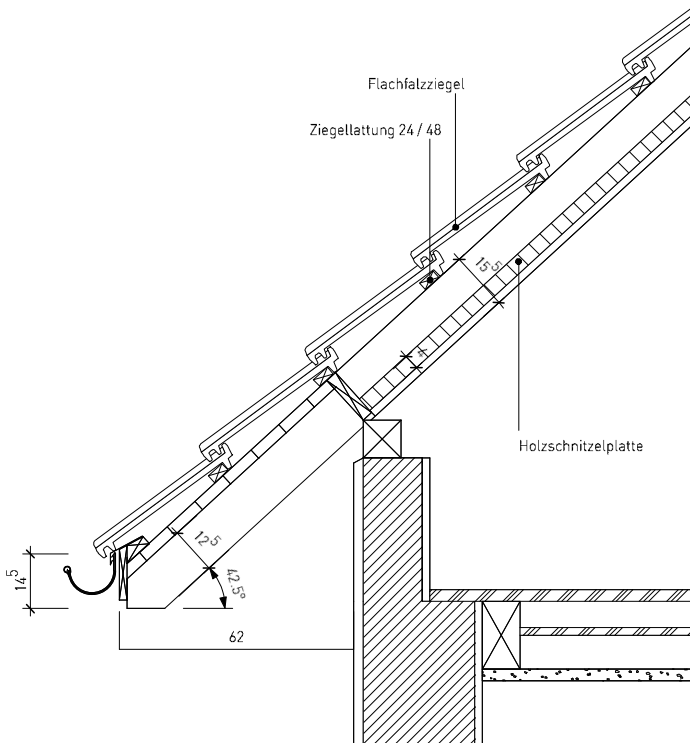
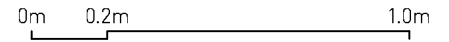

Detail Traufe Originalzustand

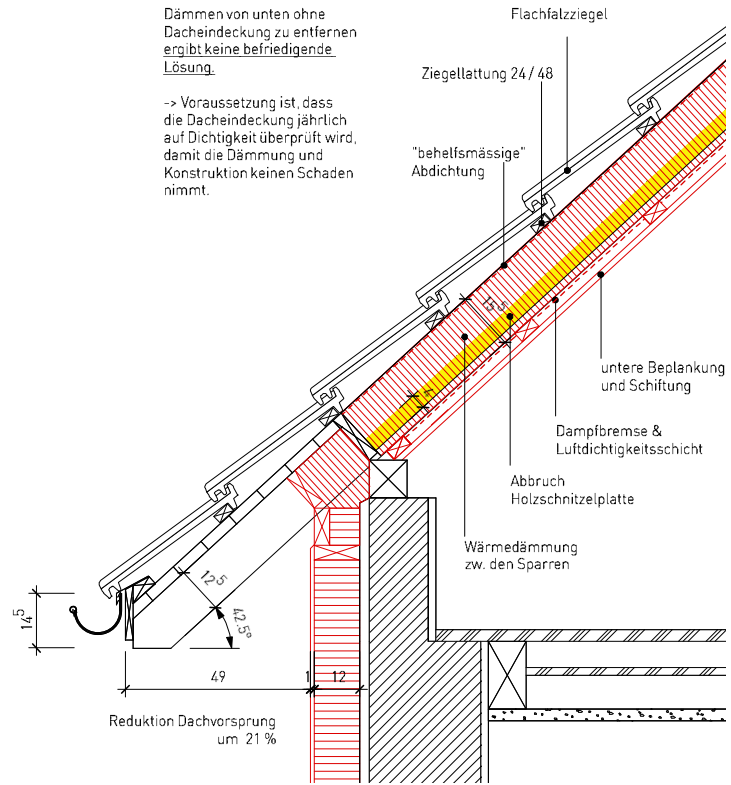

Detail Traufe saniert

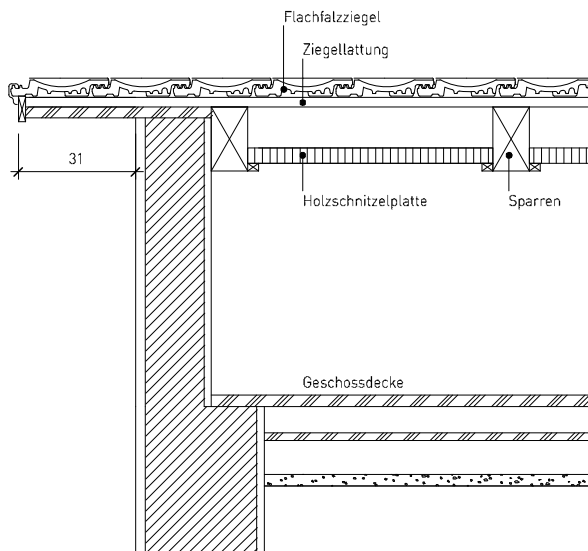

Detail Ort Originalzustand

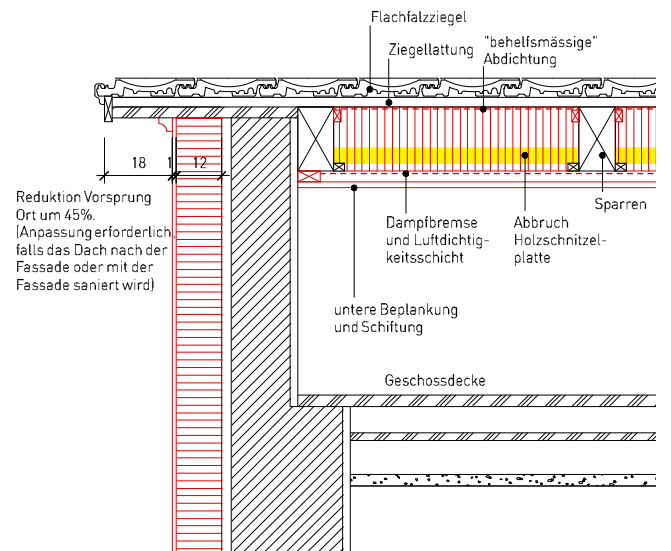

Detail Ort saniert

# Viridén + Partner Variante 2a: Energetischer Standard Eingangstüre (am Beispiel Haldenstrasse 44)

- Bestehend
- Neu
- Abbruch

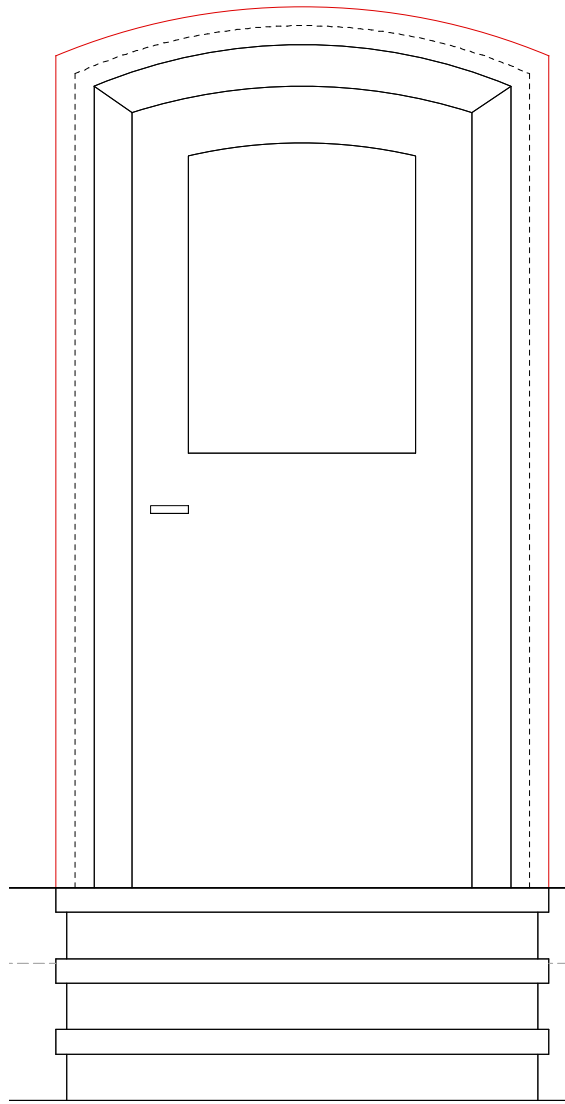

Ansicht Eingangstüre

0m 0.2m 1.0m

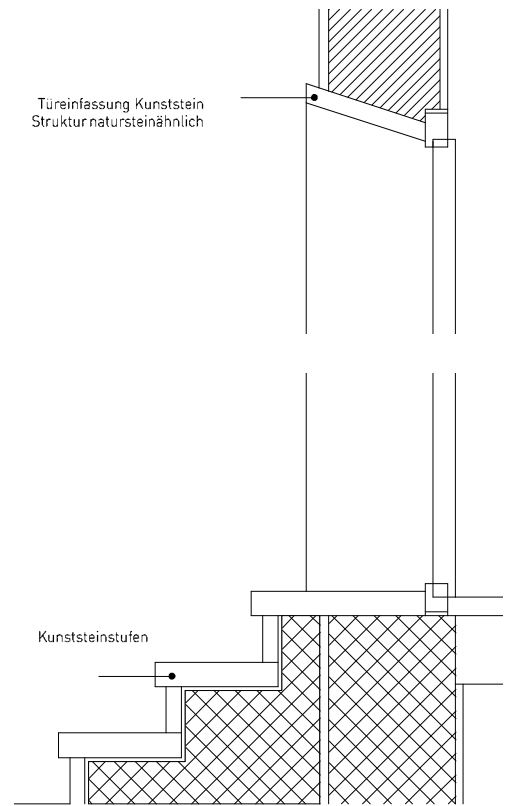

Schnitt Eingangstüre Originalzustand

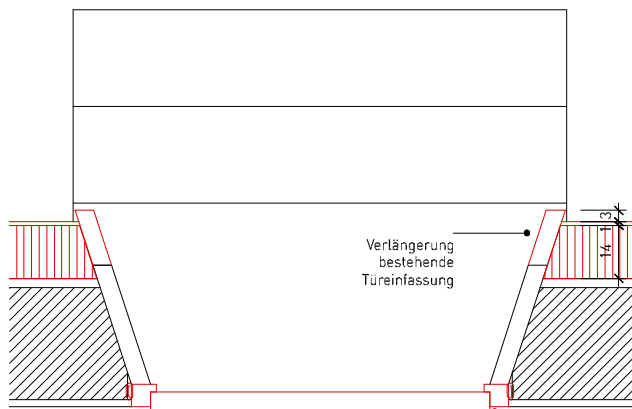

Grundriss Eingangstüre saniert

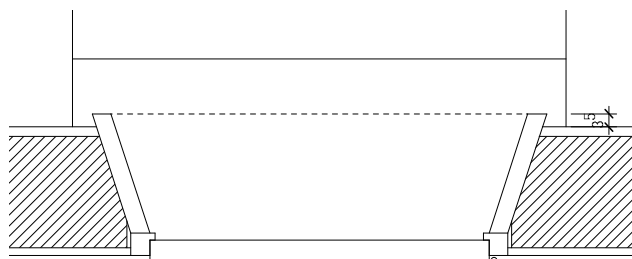

Grundriss Eingangstüre Originalzustand

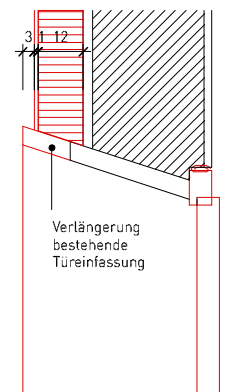

Verlängerung bestehende Türeinfassung

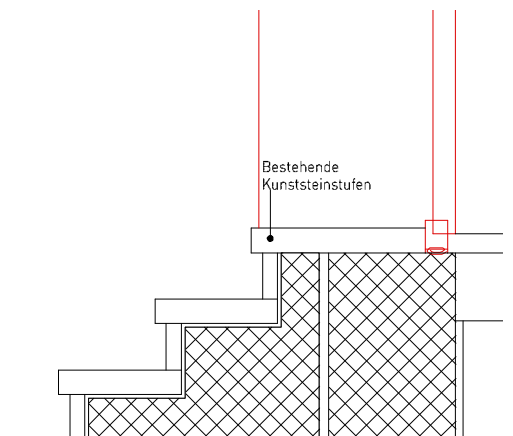

Schnitt Eingangstüre saniert

Bestehende Kunststeinstufen





Nordostfassade bestehend



Nordostfassade saniert

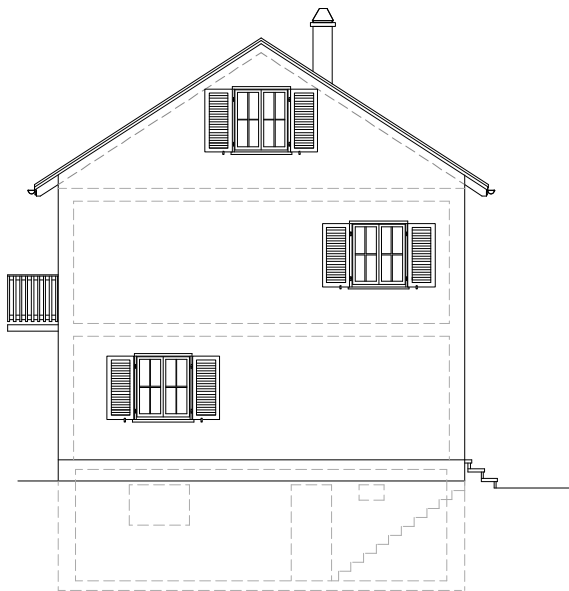

Südostfassade bestehend

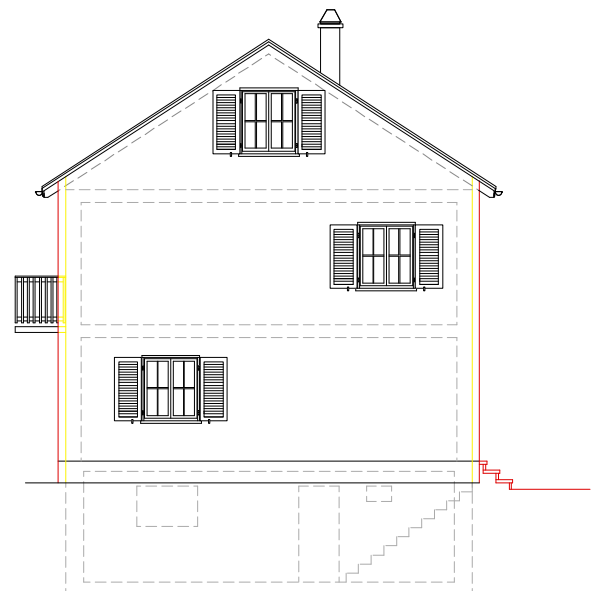

Südostfassade saniert

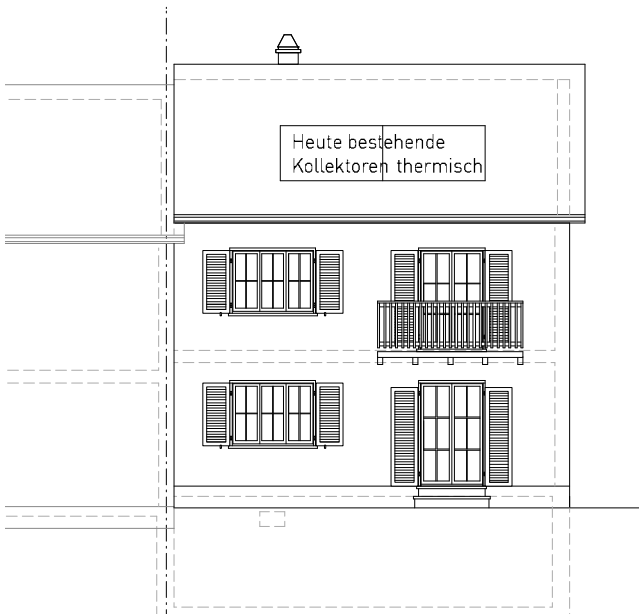

Südwestfassade bestehend

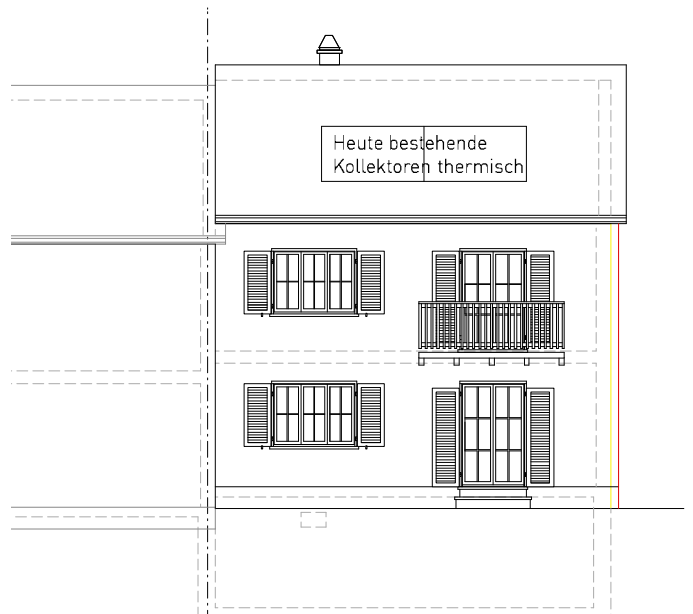

Südwestfassade saniert

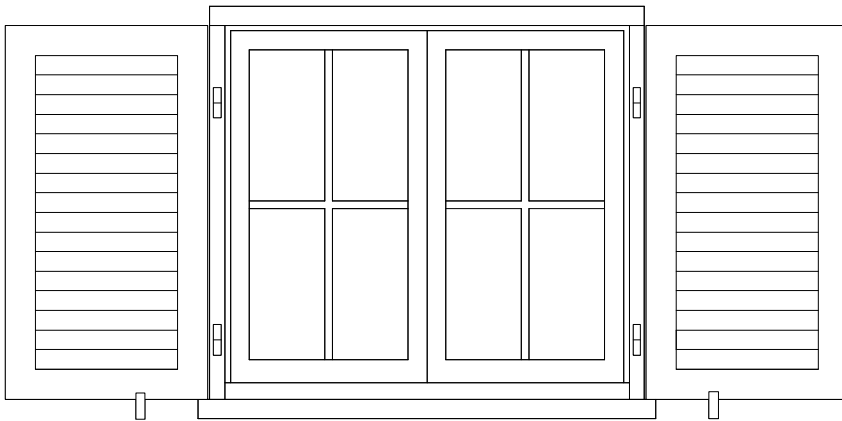
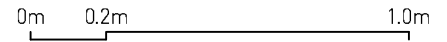

Ansicht

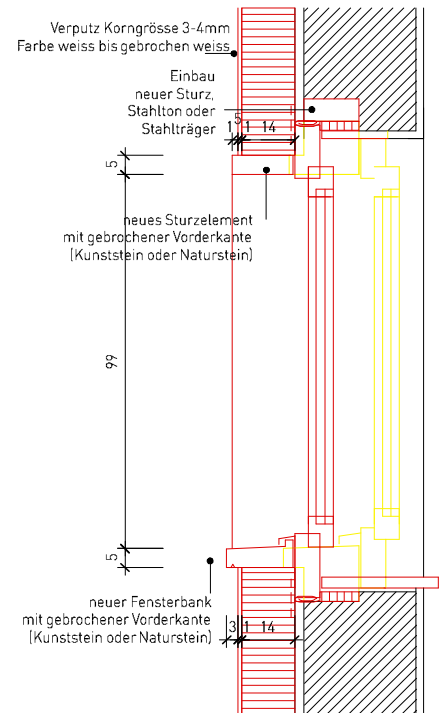

Schnitt Fenster saniert

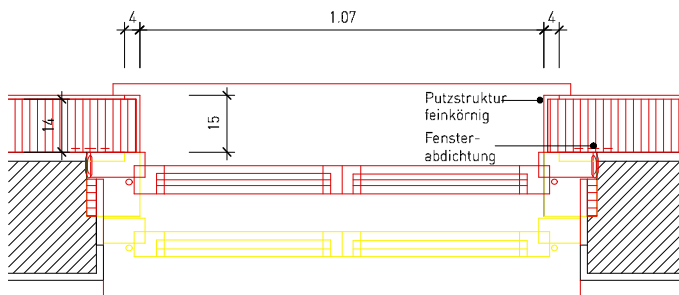

Grundriss Fenster saniert

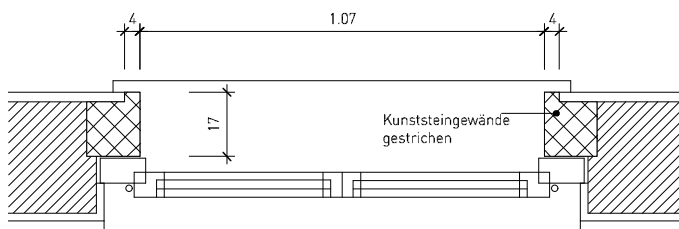

Grundriss Originalzustand

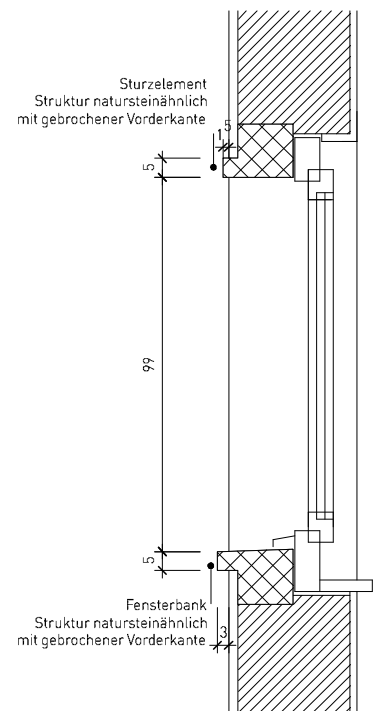

Schnitt Fenster Originalzustand

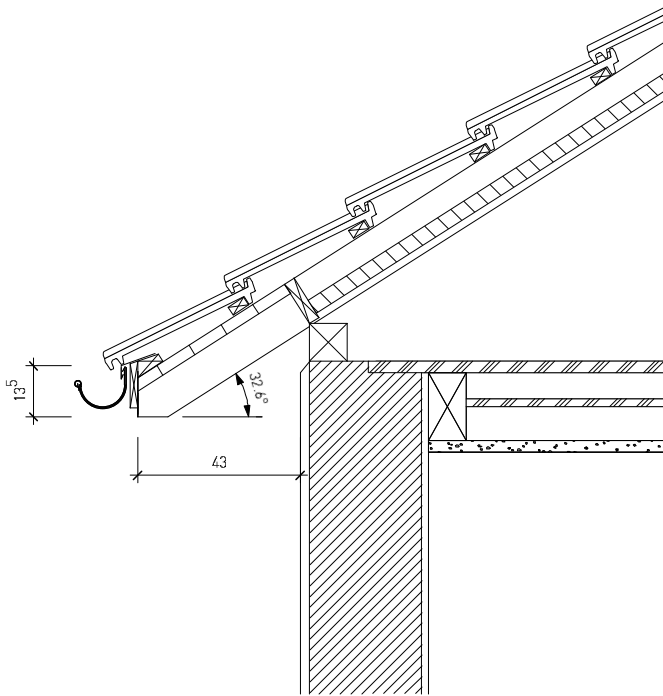
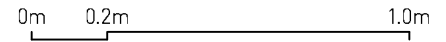

Detail Traufe Originalzustand

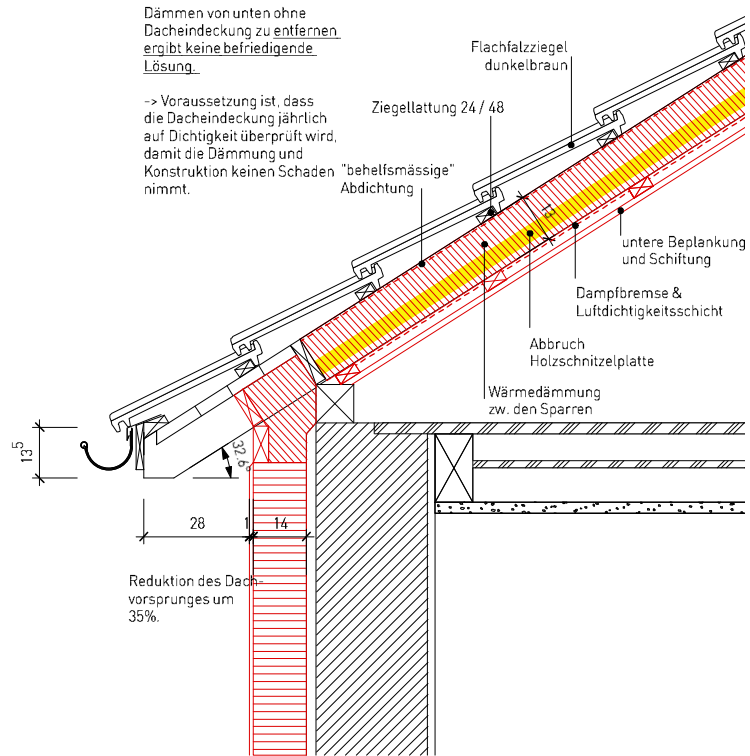

Detail Traufe saniert

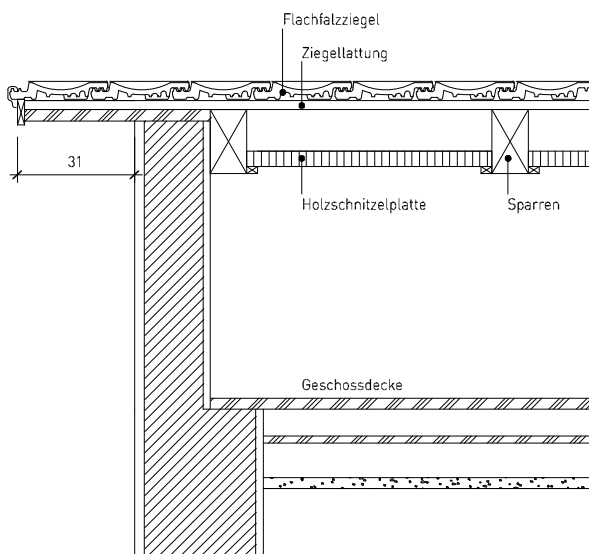

Detail Ort Originalzustand

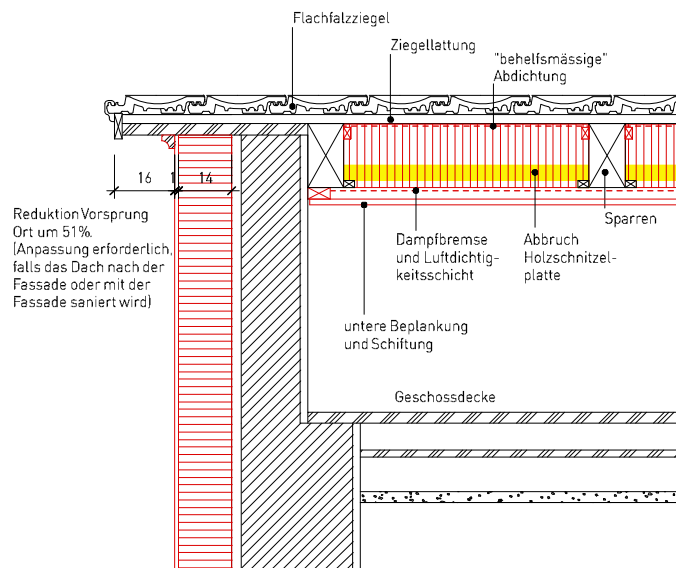

Detail Ort saniert

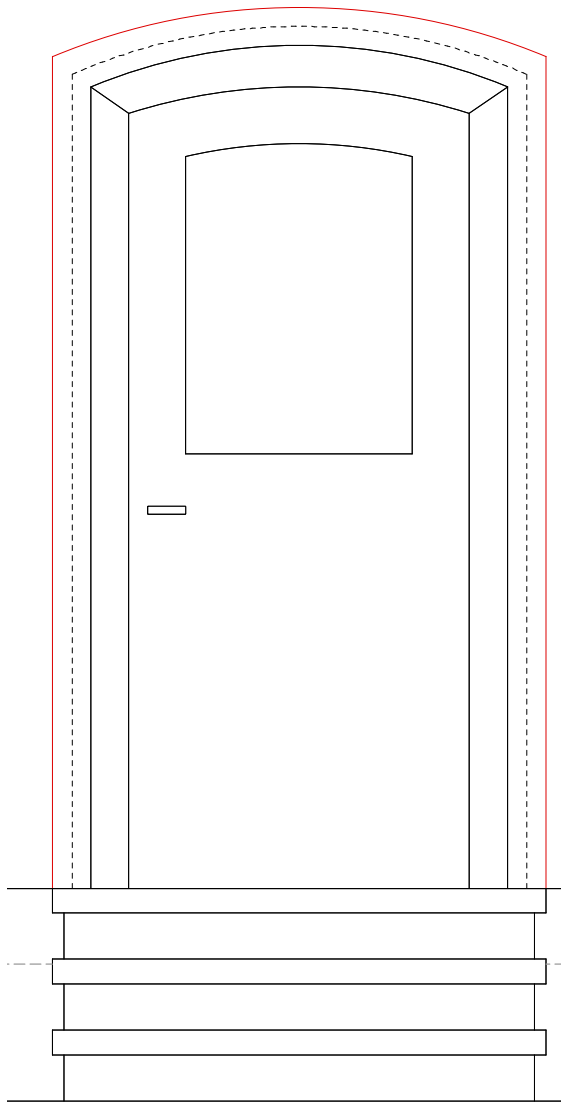

Ansicht Eingangstüre

0m 0.2m 1.0m

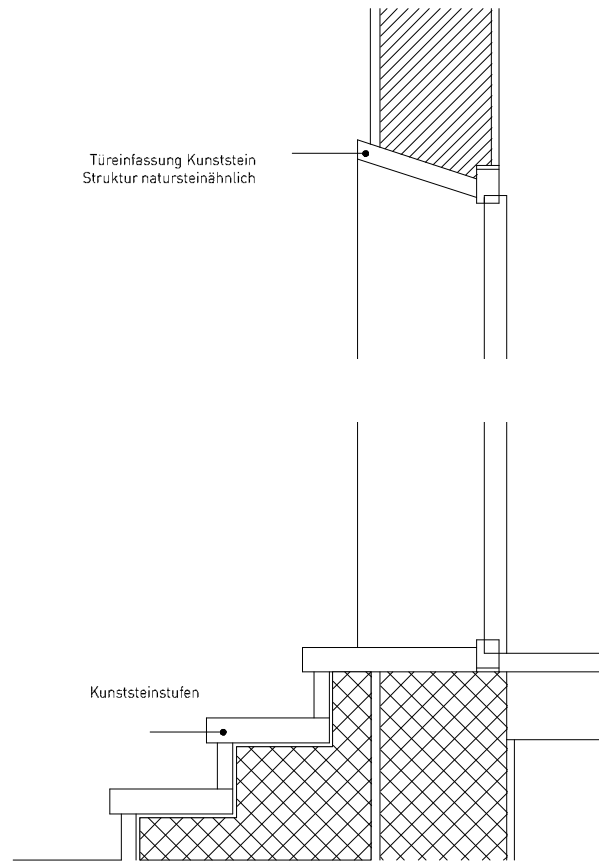

Türeinfassung Kunststein  
Struktur natursteinähnlich

Kunststeinstufen

Schnitt Eingangstüre Originalzustand

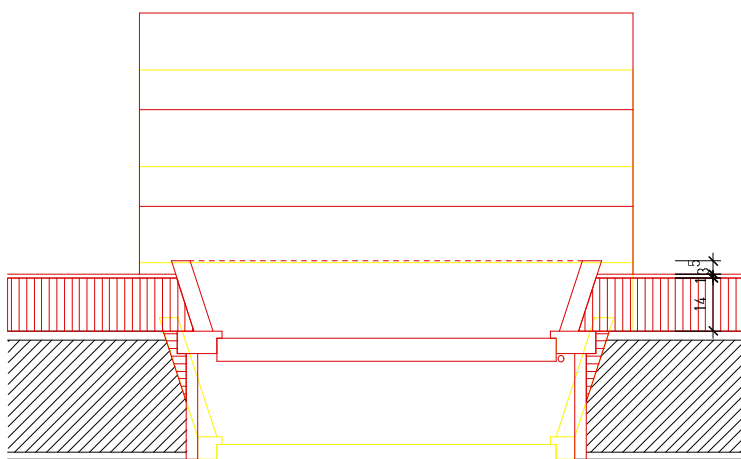

Grundriss Eingangstüre saniert

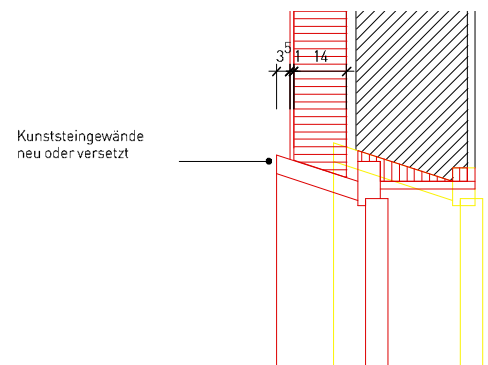

Kunststeingewände  
neu oder versetzt

Kunststeinstufen  
nach Aussen  
versetzt oder neu

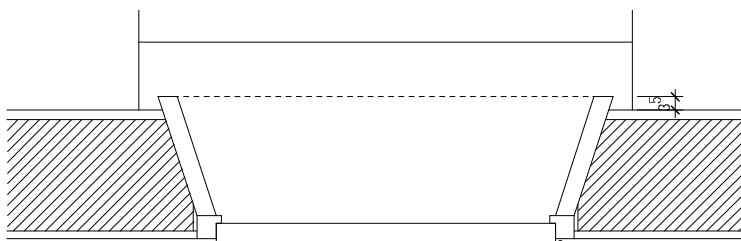

Grundriss Eingangstüre Originalzustand

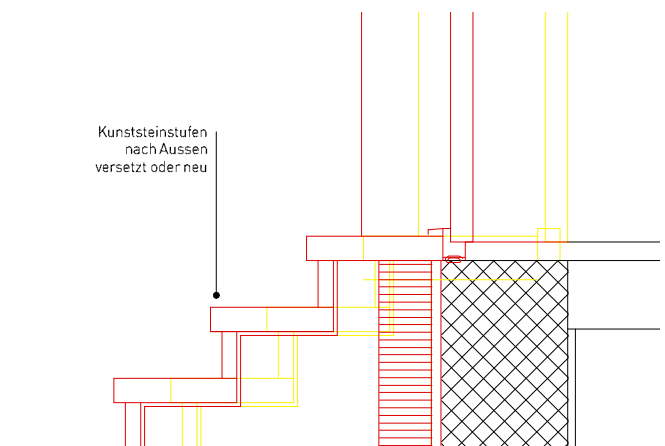

Schnitt Eingangstüre saniert

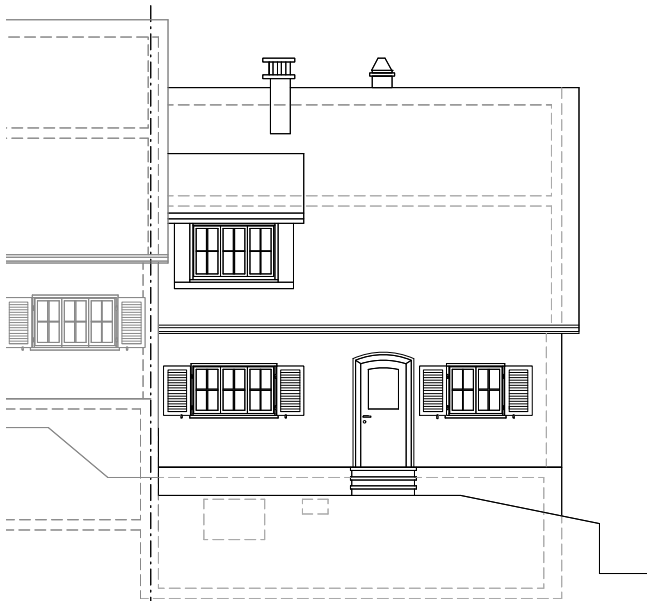

Nordostfassade bestehend

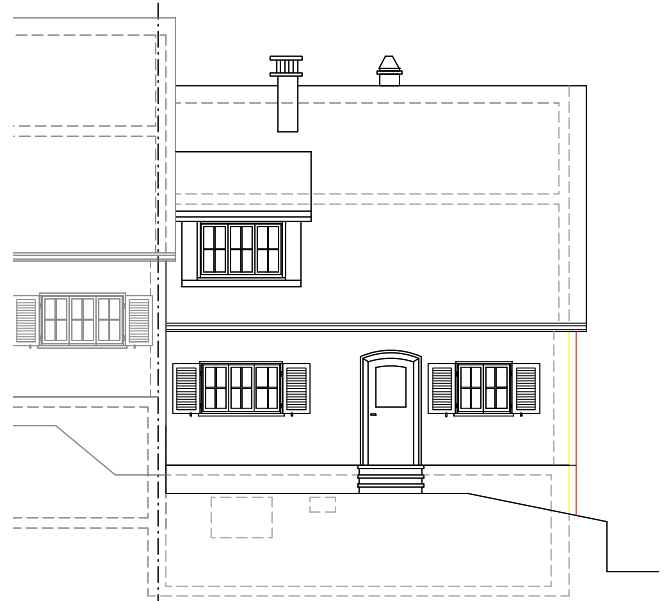

Nordostfassade saniert



Nordwestfassade bestehend



Nordwestfassade saniert

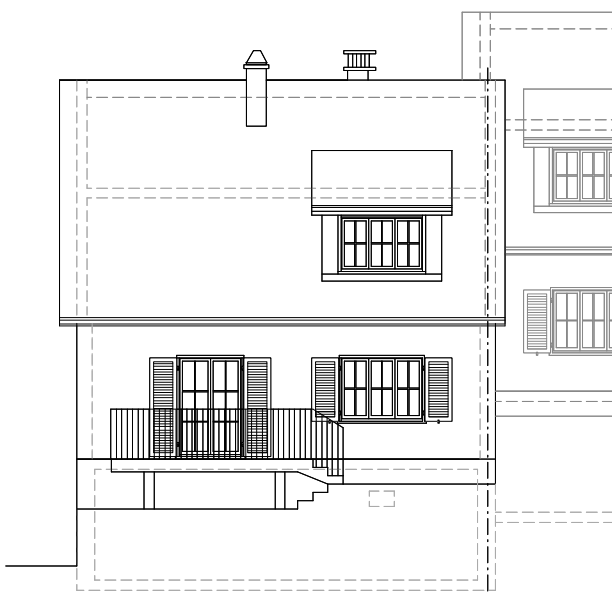

Südwestfassade bestehend

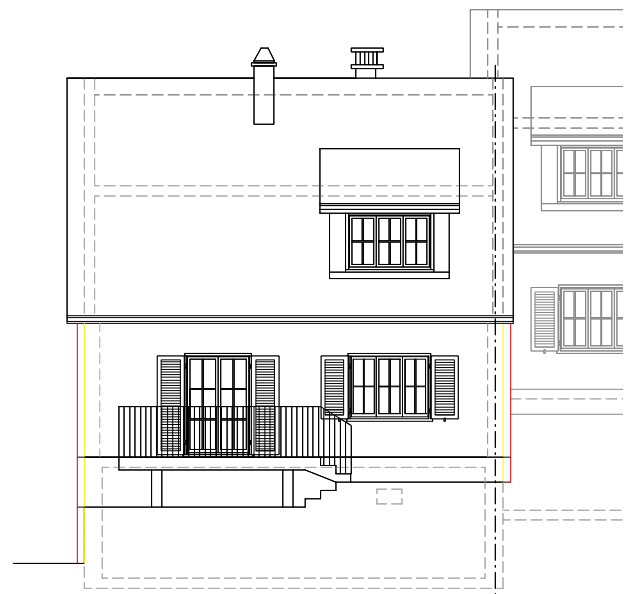

Südwestfassade saniert

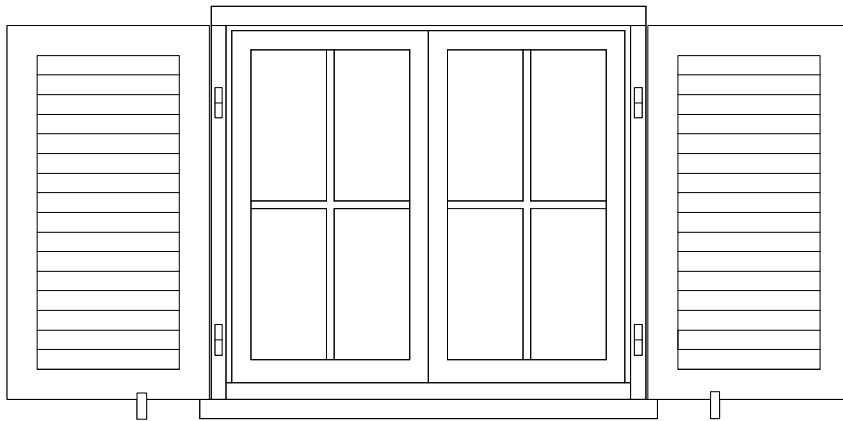

Ansicht

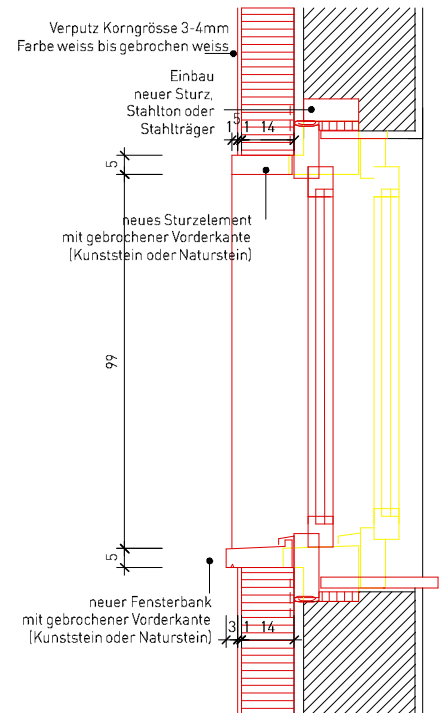
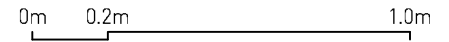

Schnitt Fenster saniert

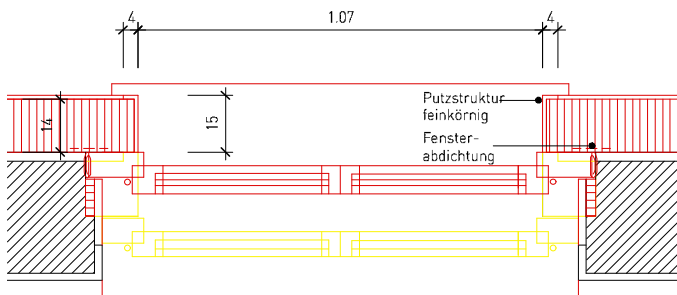

Grundriss Fenster saniert

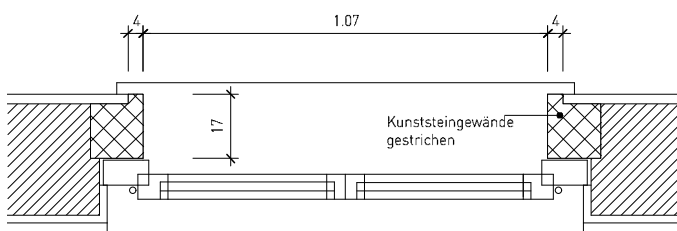

Grundriss Originalzustand

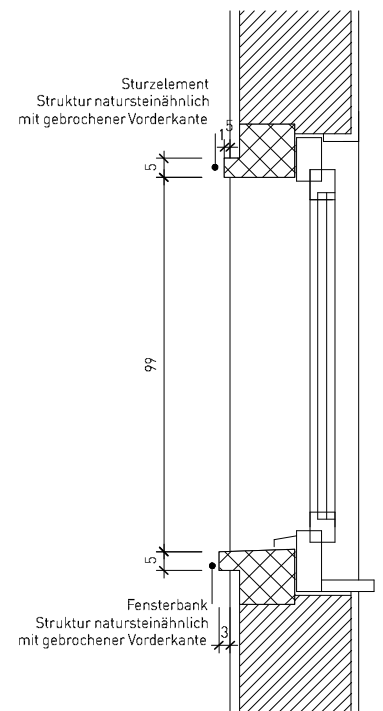

Schnitt Fenster Originalzustand

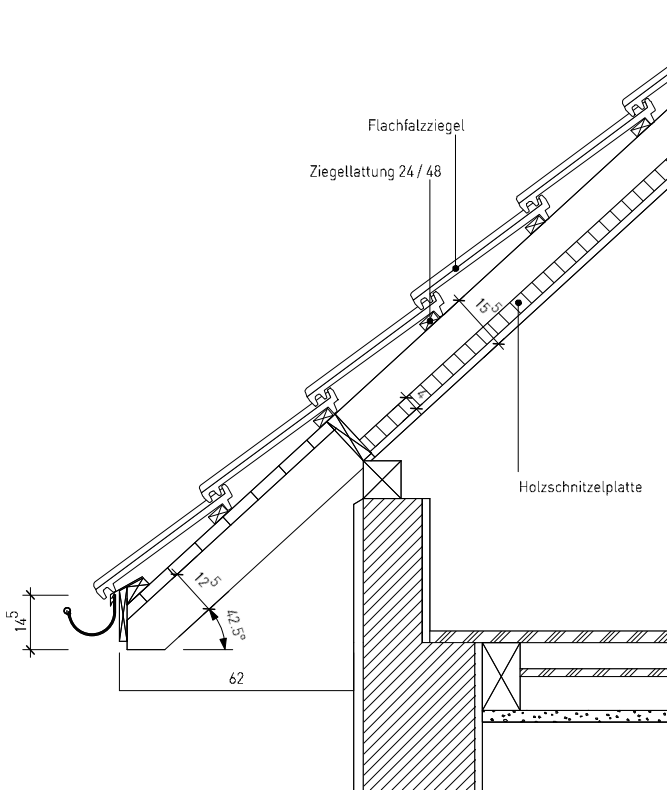
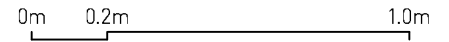

Detail Traufe Originalzustand

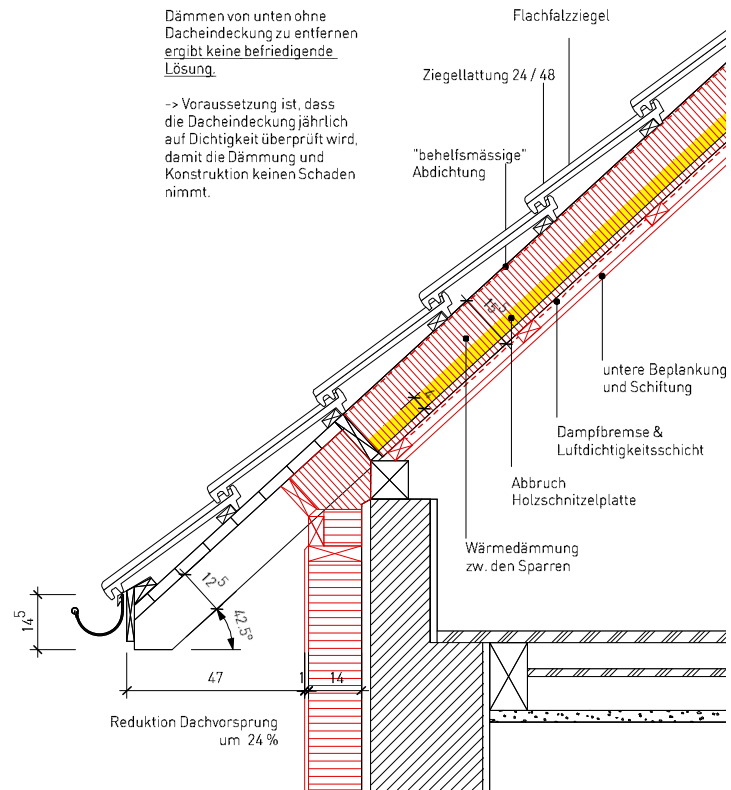

Detail Traufe saniert

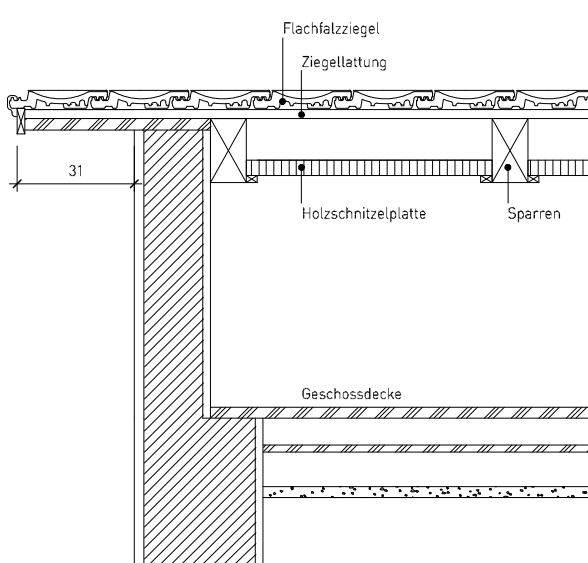

Detail Ort Originalzustand

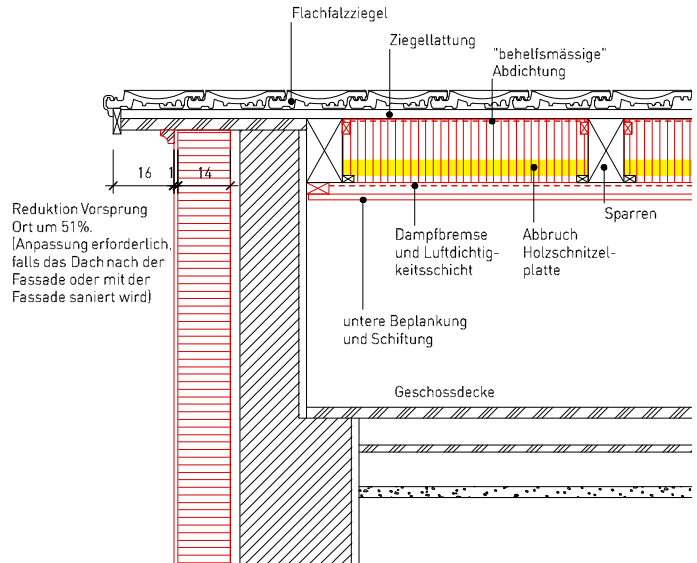

Detail Ort saniert

# Viridén + Variante 2b: Standard Plus

## + Partner Eingangstüre (am Beispiel Haldenstrasse 44)

- Bestehend
- Neu
- Abbruch

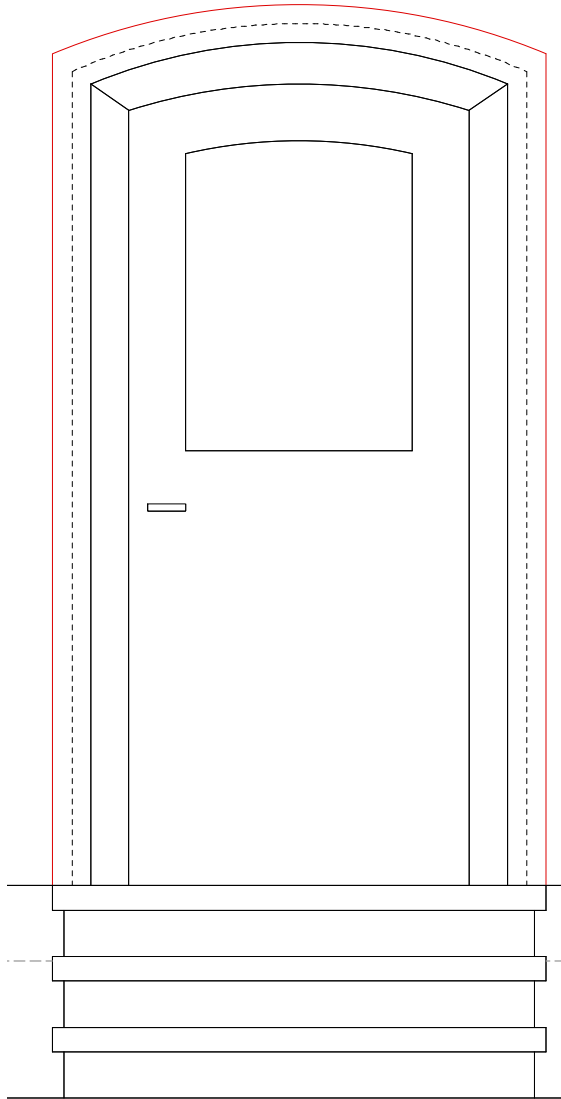

Ansicht Eingangstüre

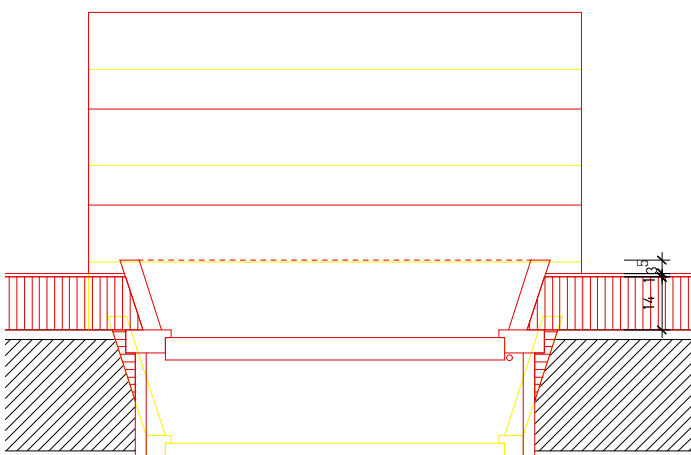

Grundriss Eingangstüre saniert

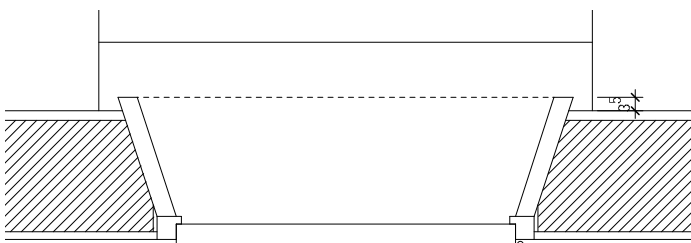

Grundriss Eingangstüre Originalzustand

0m 0.2m 1.0m

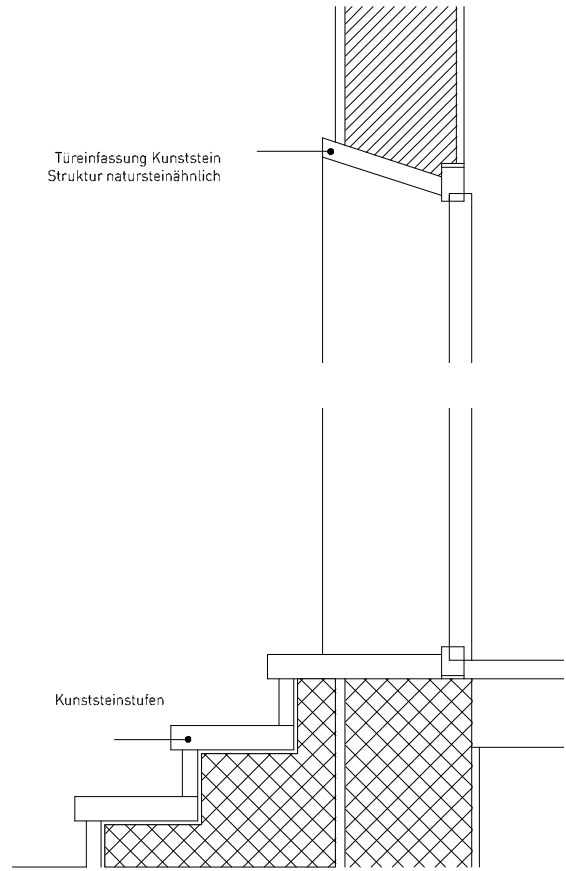

Türeinfassung Kunststein  
Struktur natursteinähnlich

Kunststeinstufen

Schnitt Eingangstüre Originalzustand

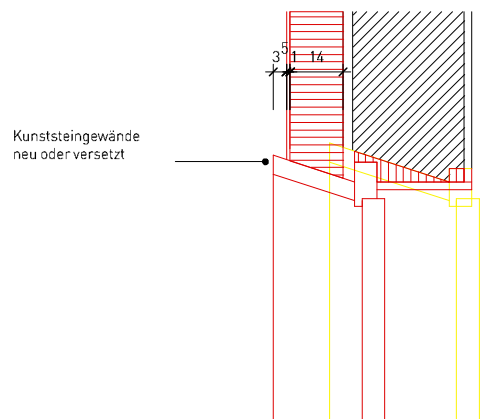

Kunststeingewände  
neu oder versetzt

Kunststeinstufen  
nach Aussen  
versetzt oder neu

Schnitt Eingangstüre saniert





Nordostfassade bestehend

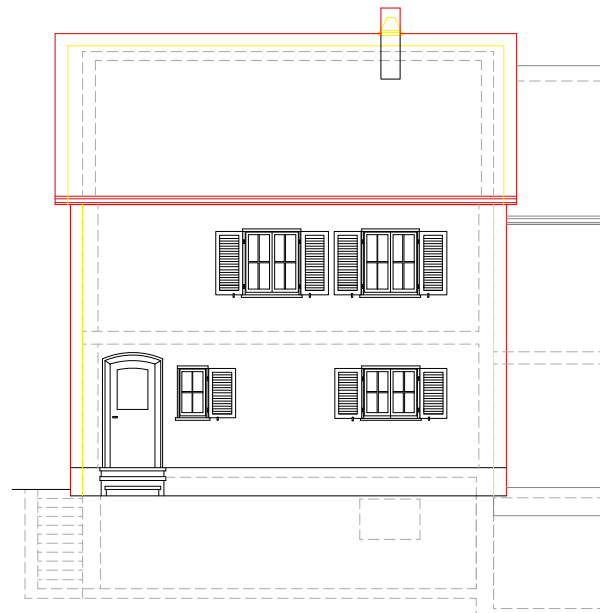

Nordostfassade saniert

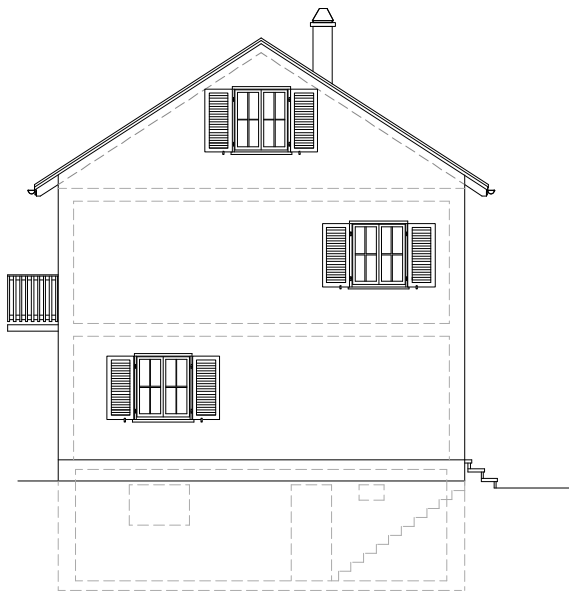

Südostfassade bestehend

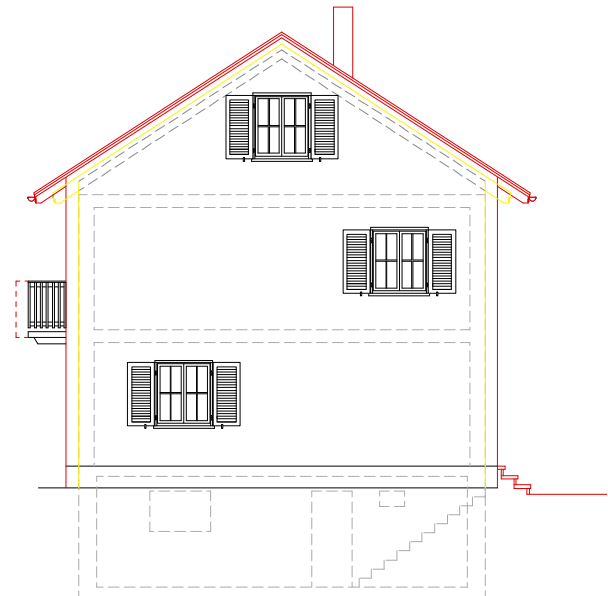

Südostfassade saniert

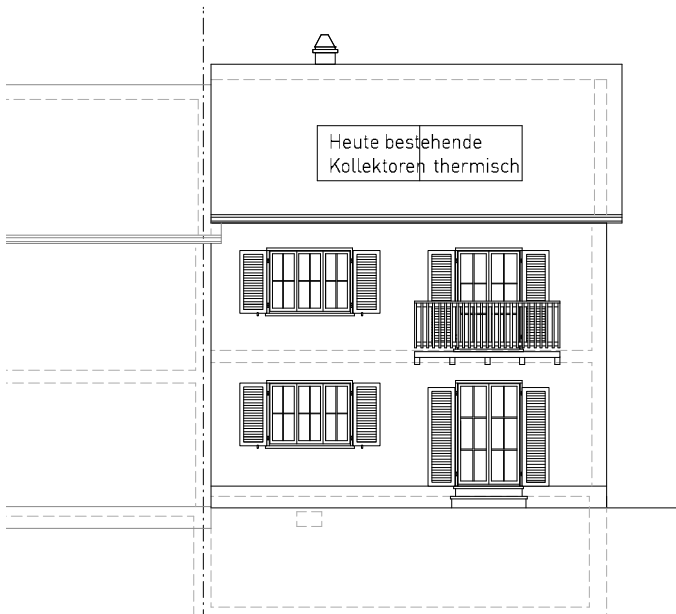

Südwestfassade bestehend



Südwestfassade saniert

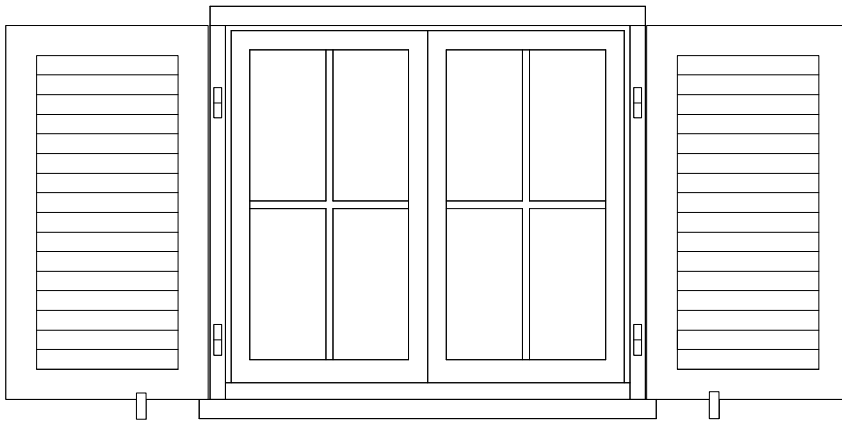
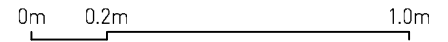

Ansicht

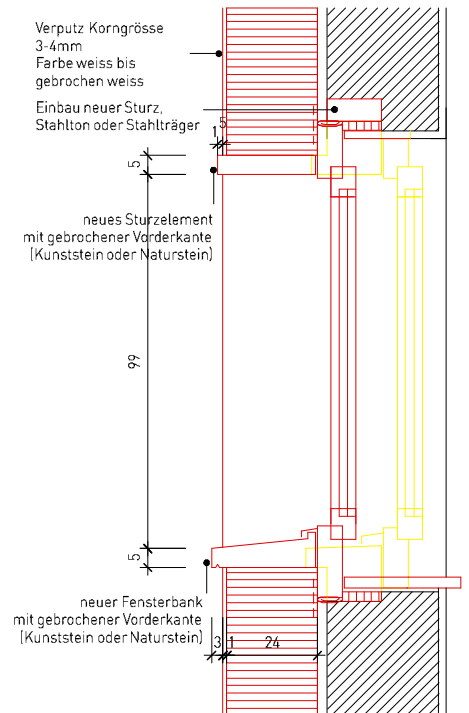

Schnitt Fenster saniert

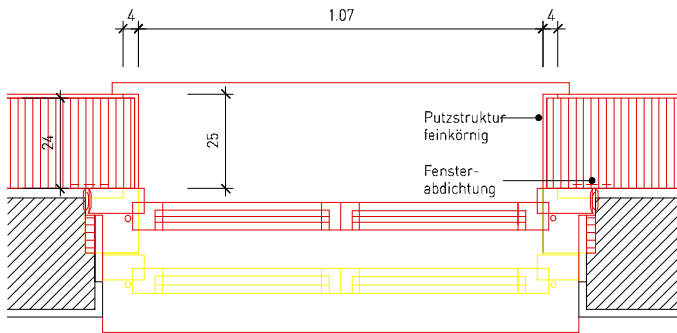

Grundriss Fenster saniert

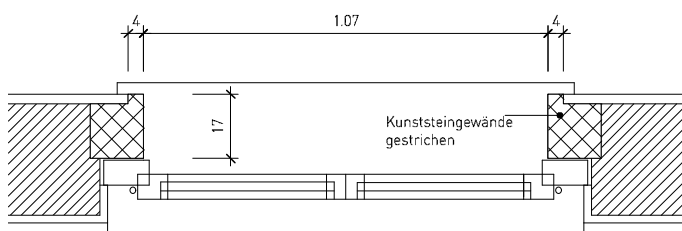

Grundriss Originalzustand

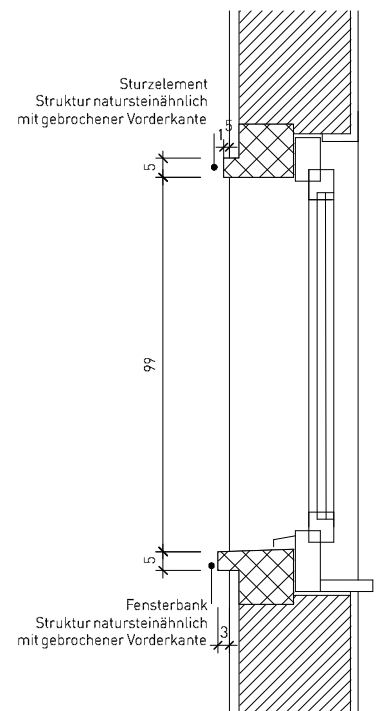

Schnitt Fenster Originalzustand

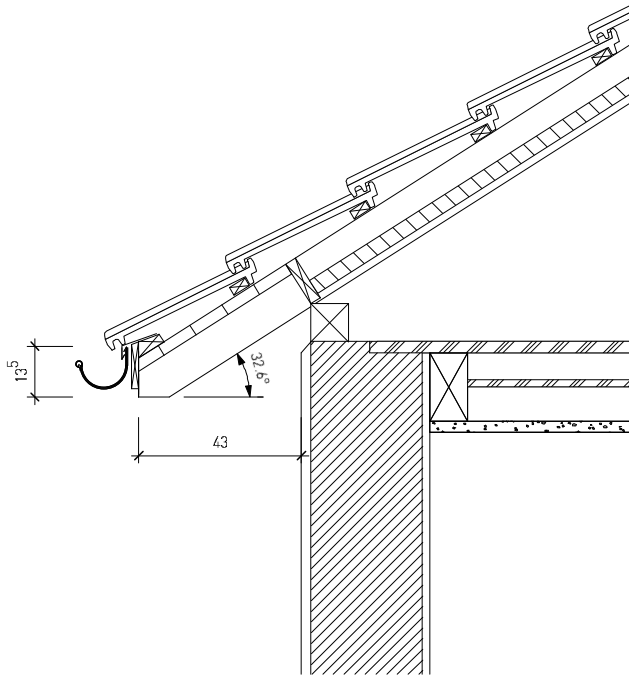

Detail Traufe Originalzustand

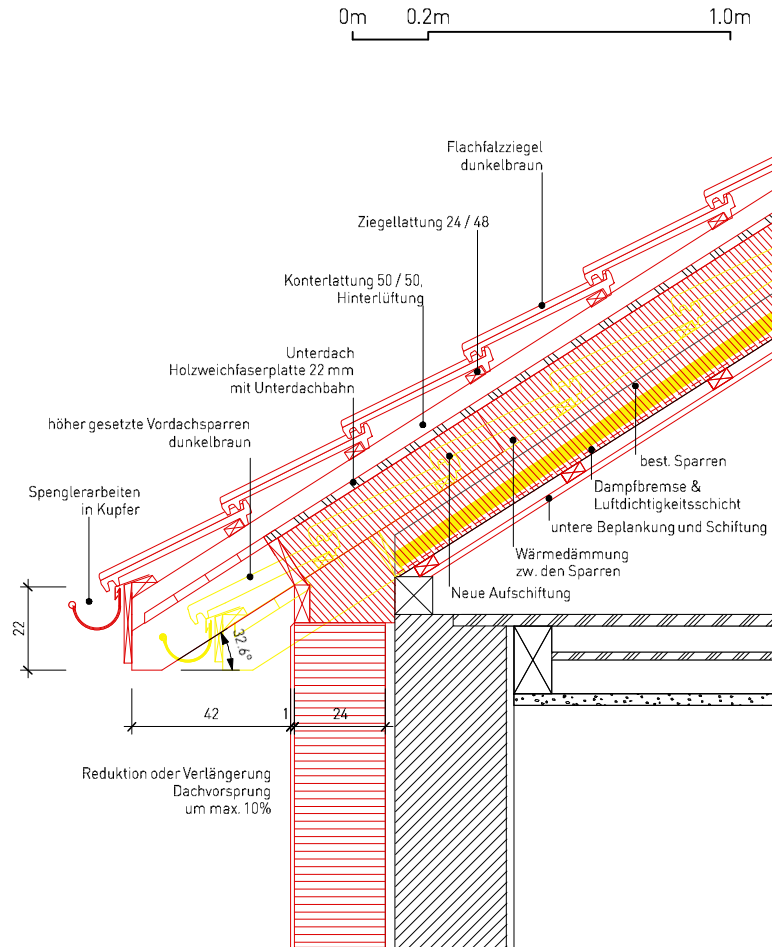

Detail Traufe saniert

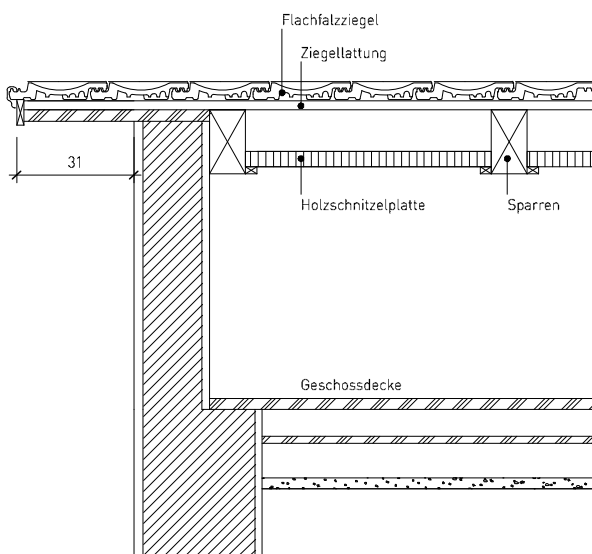

Detail Ort Originalzustand

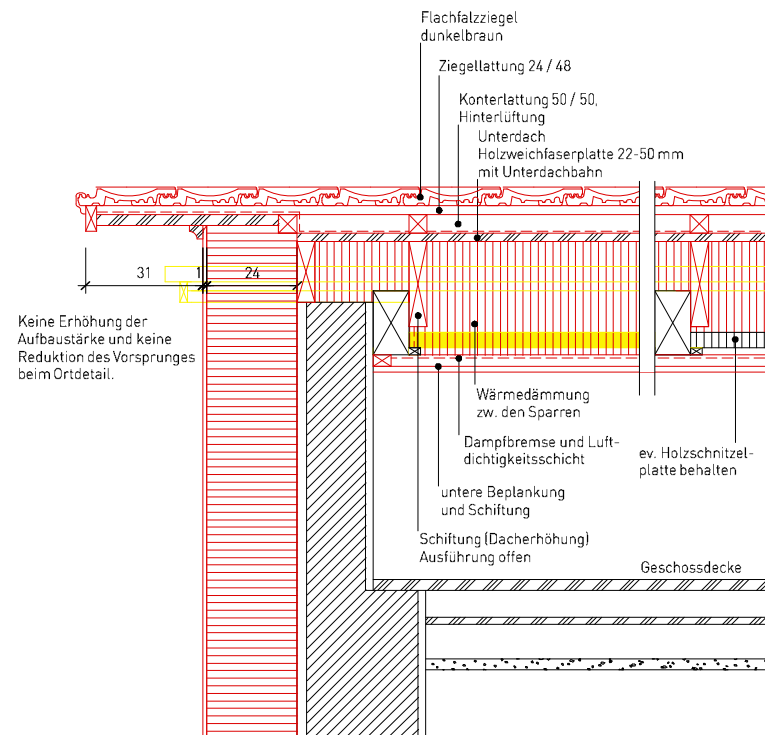

Detail Ort saniert

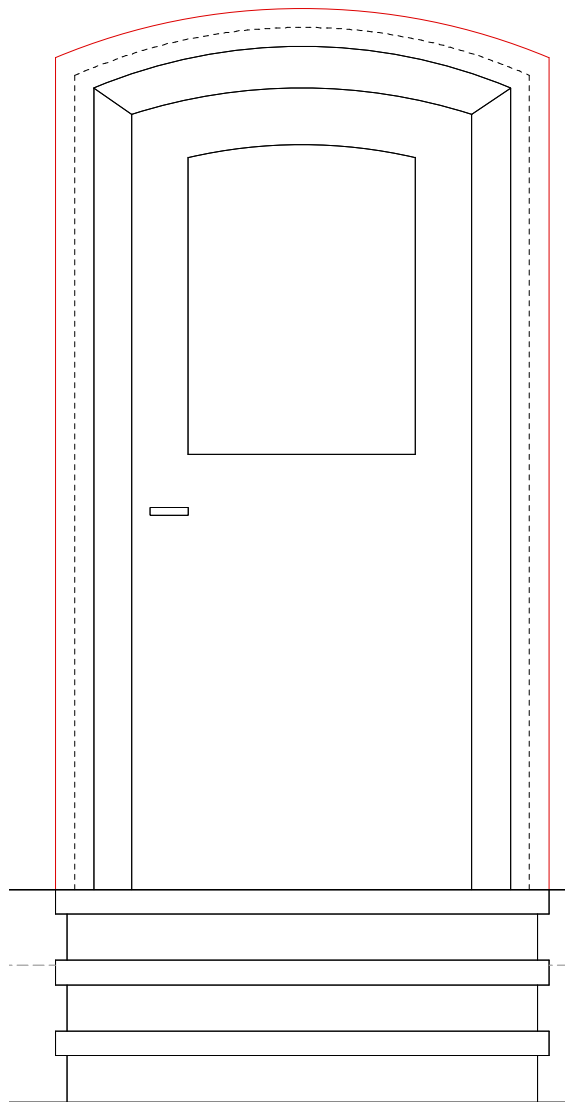

Ansicht Eingangstüre

0m 0.2m 1.0m

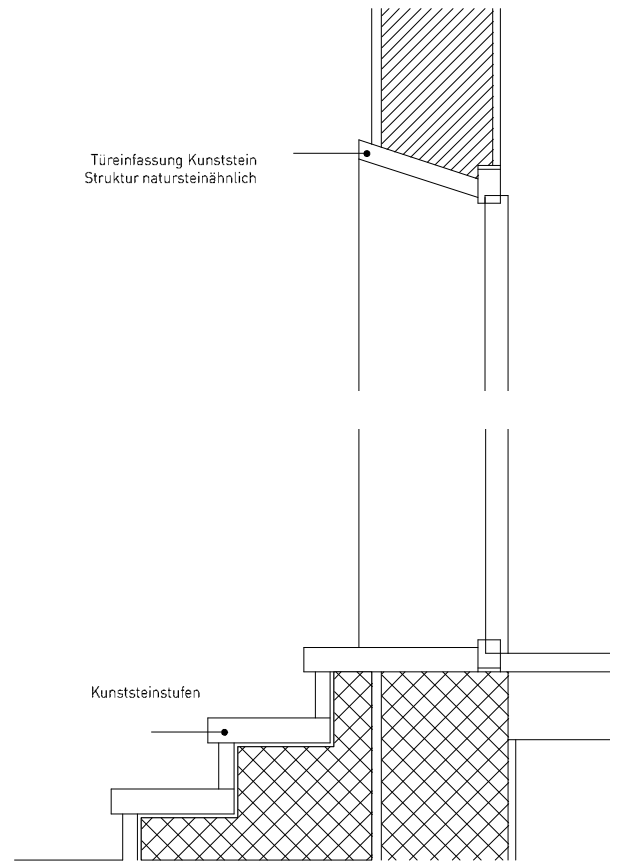

Schnitt Eingangstüre Originalzustand

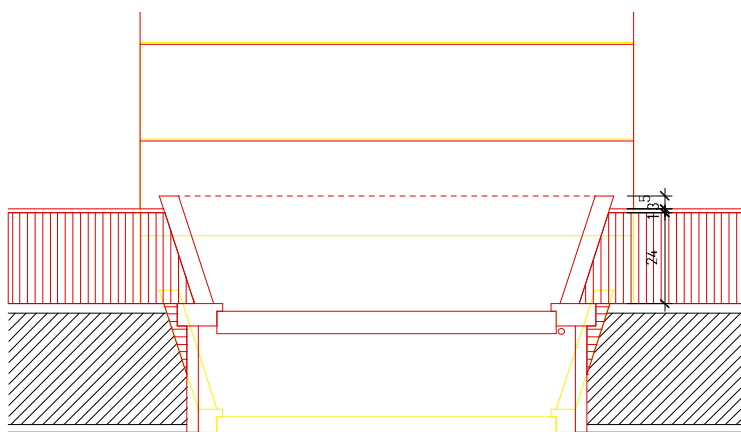

Grundriss Eingangstüre saniert

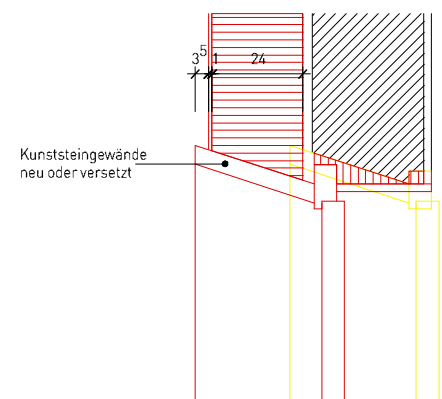

Schnitt Eingangstüre saniert

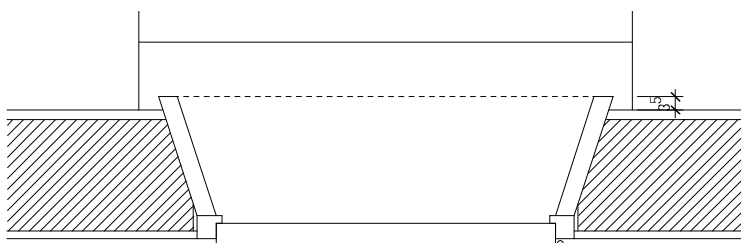

Grundriss Eingangstüre Originalzustand

0m 0.2m 1.0m

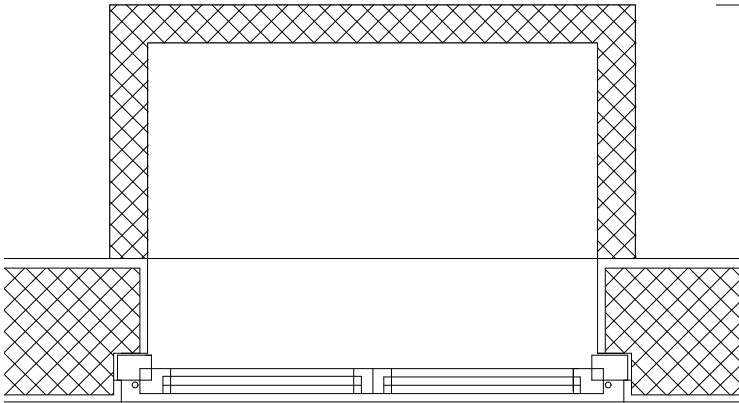

Grundriss Kellerfenster  
Originalzustand

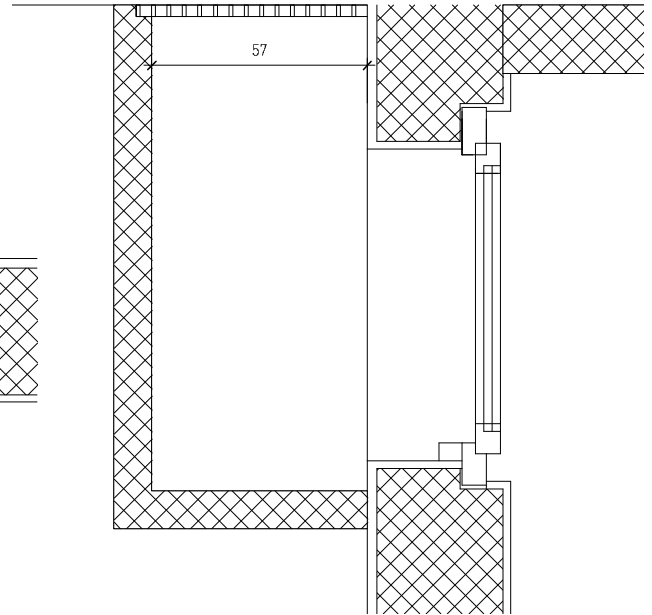

Schnitt Kellerfenster  
Originalzustand

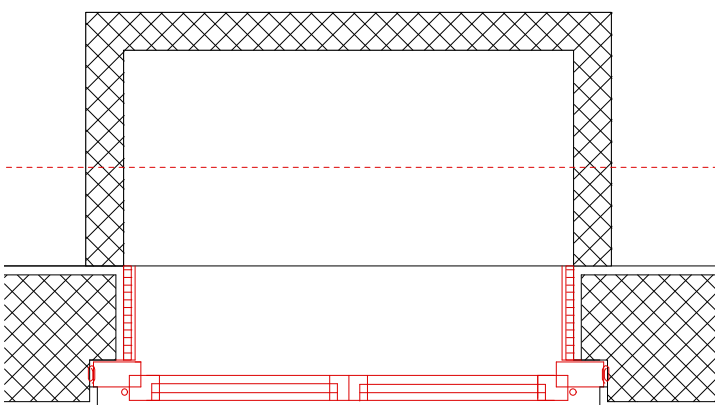

Grundriss Kellerfenster  
saniert

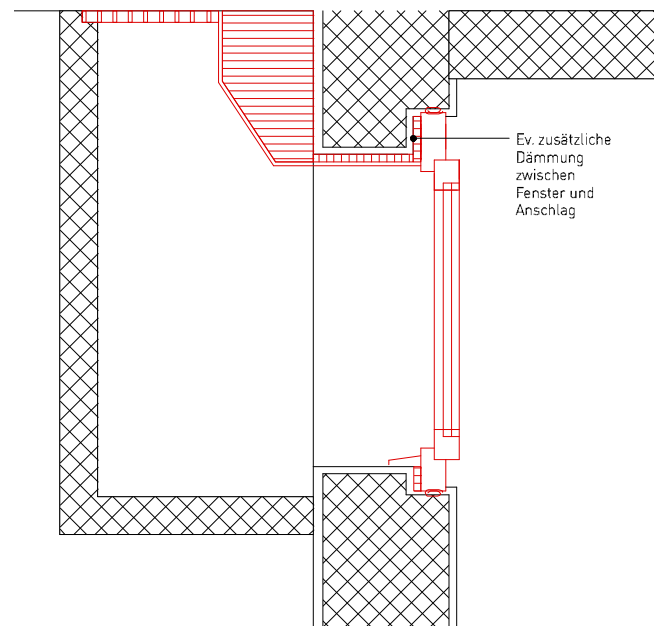

Schnitt Kellerfenster  
saniert

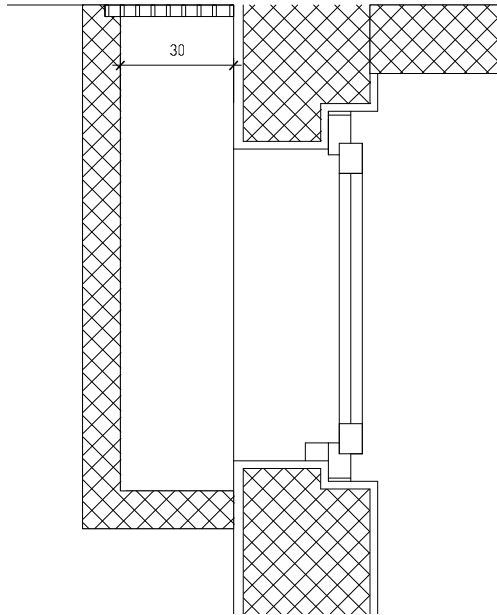
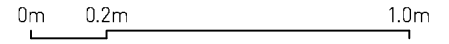

Schnitt Kellerfenster  
Originalzustand

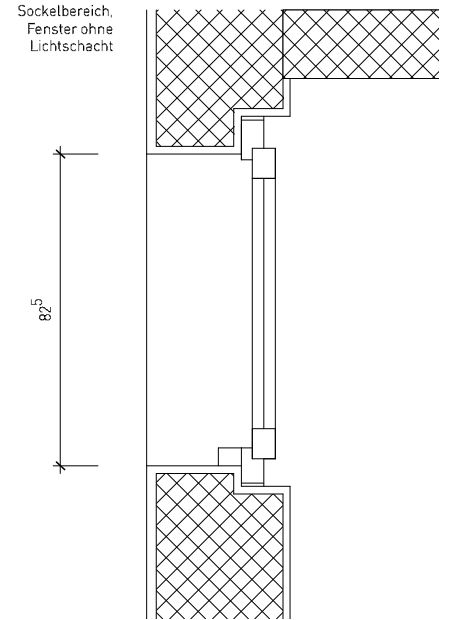

Schnitt Kellerfenster  
(ohne Lichtschacht)  
Originalzustand

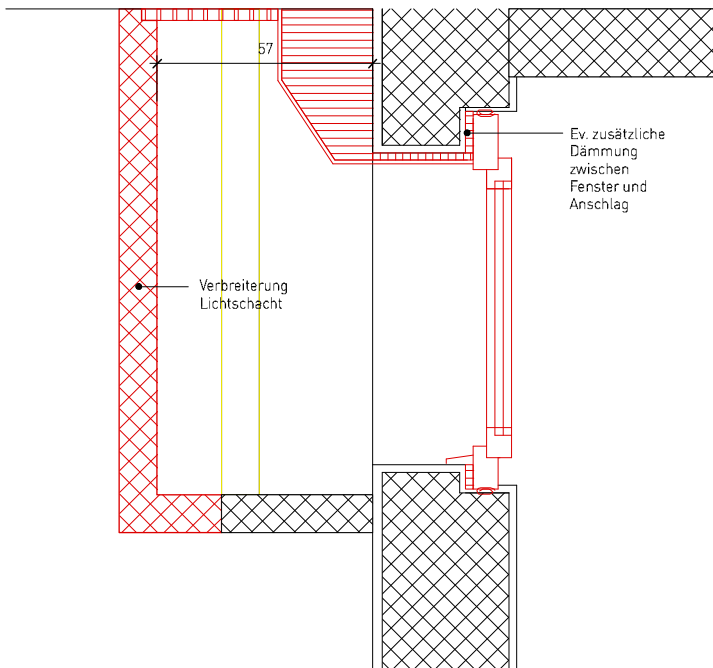

Schnitt Kellerfenster  
saniert

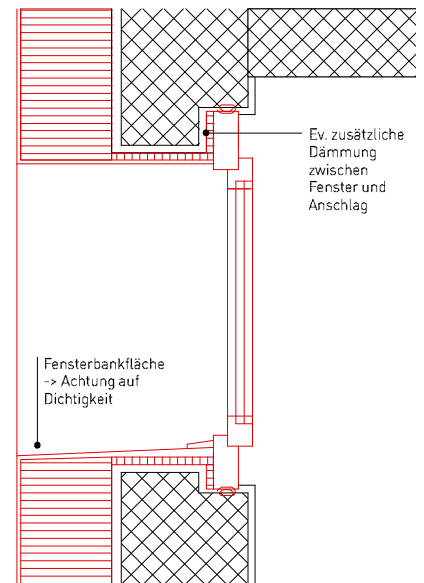

Schnitt Kellerfenster  
(ohne Lichtschacht)  
saniert

0m 0.2m 1.0m

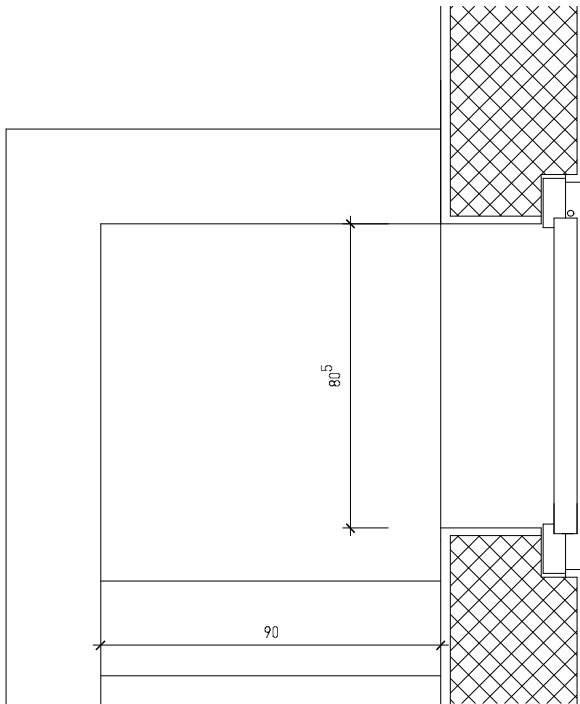

Grundriss Kellertüre Originalzustand

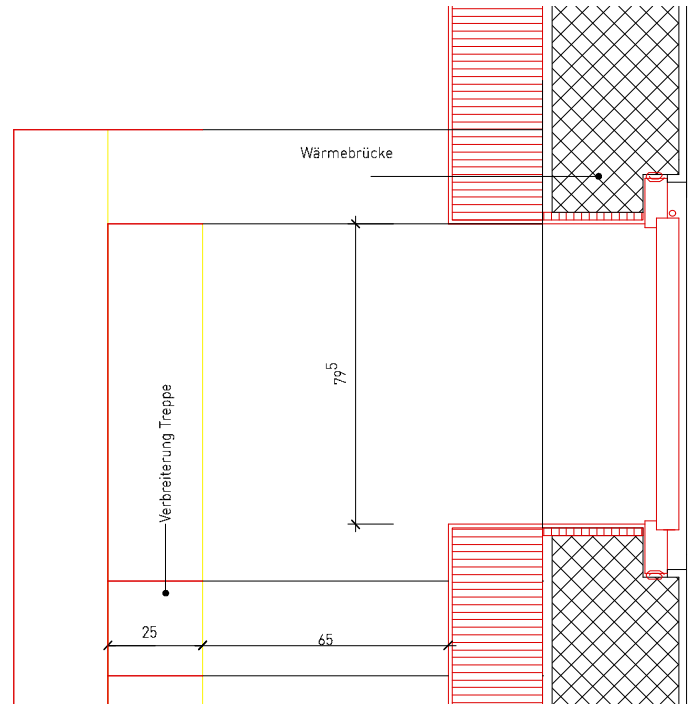

Grundriss Kellertüre saniert

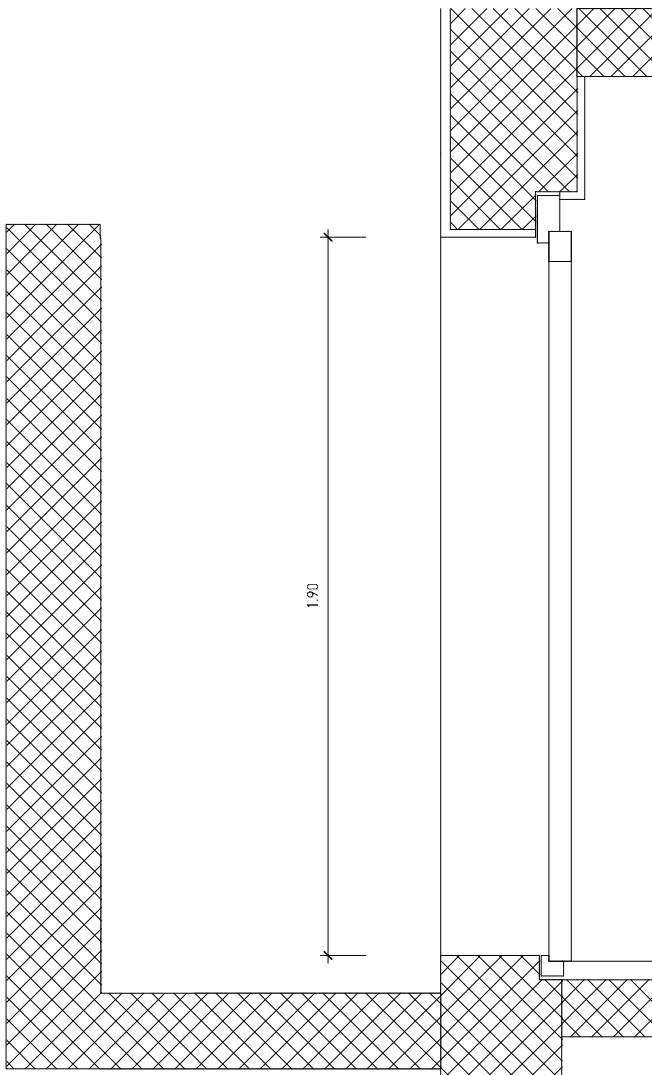

Schnitt Kellertüre Originalzustand

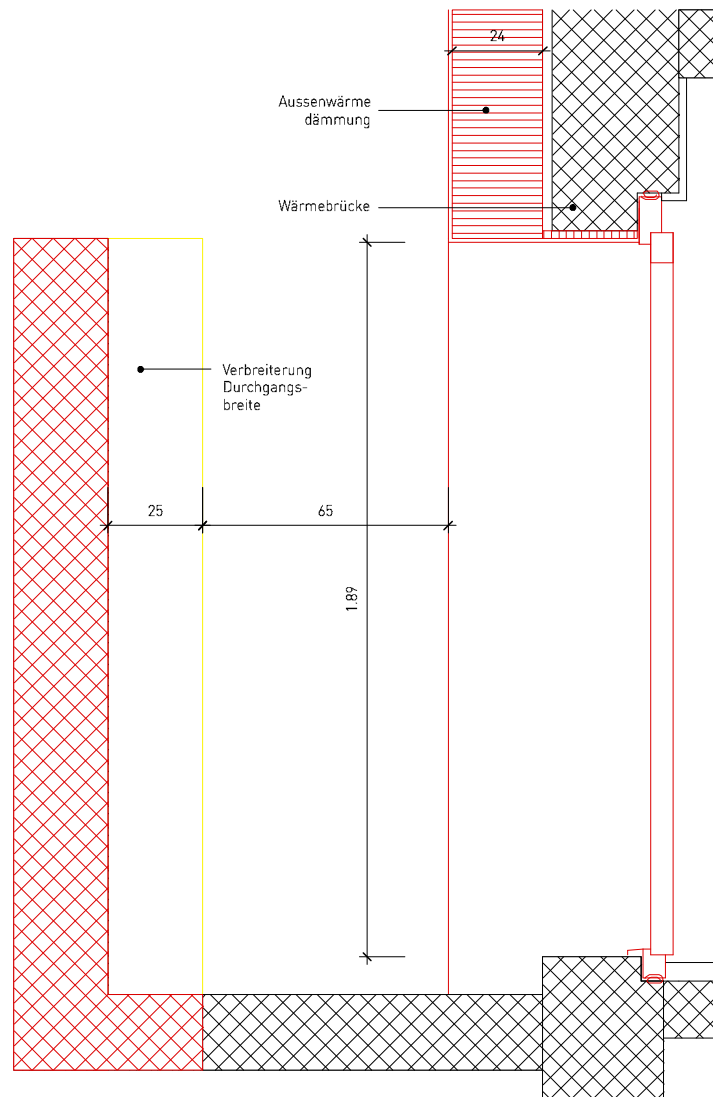

Schnitt Kellertüre saniert

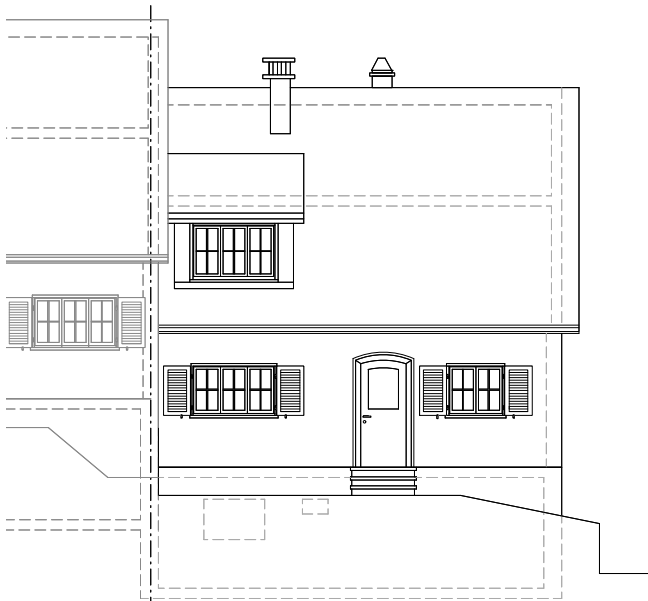

Nordostfassade bestehend

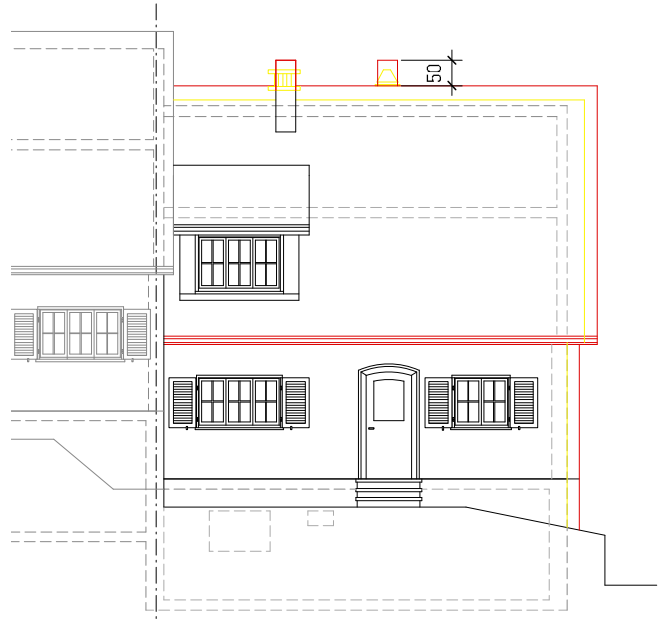

Nordostfassade saniert



Nordwestfassade bestehend

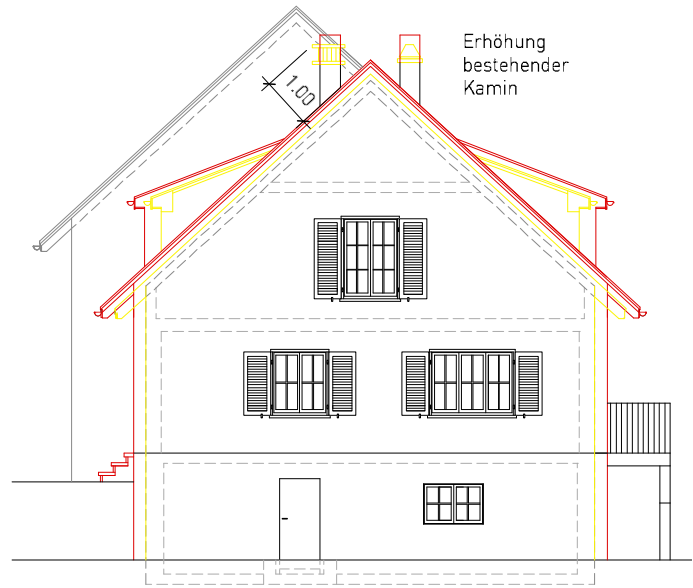

Nordwestfassade saniert

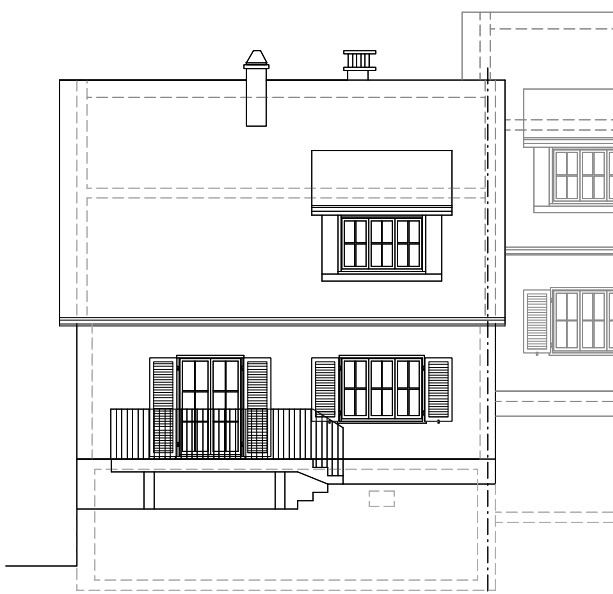

Südwestfassade bestehend

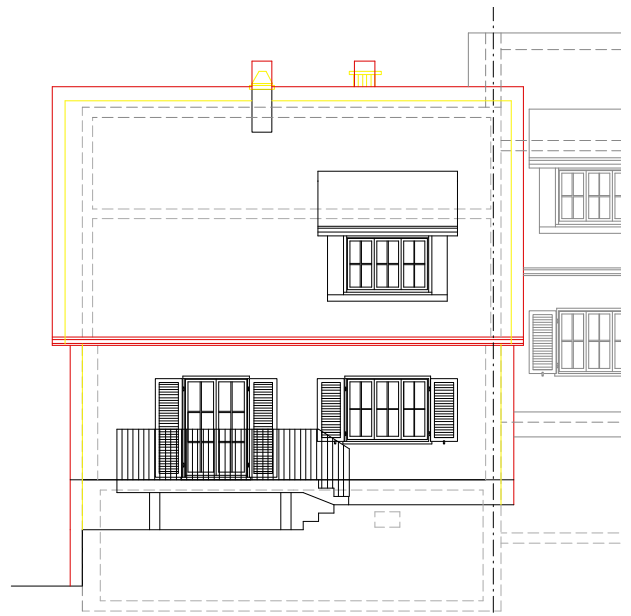

Südwestfassade saniert



0m 0.2m 1.0m

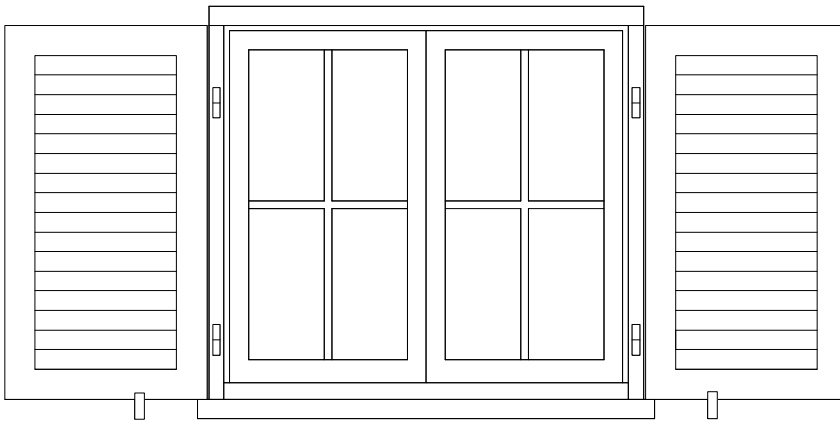

Ansicht

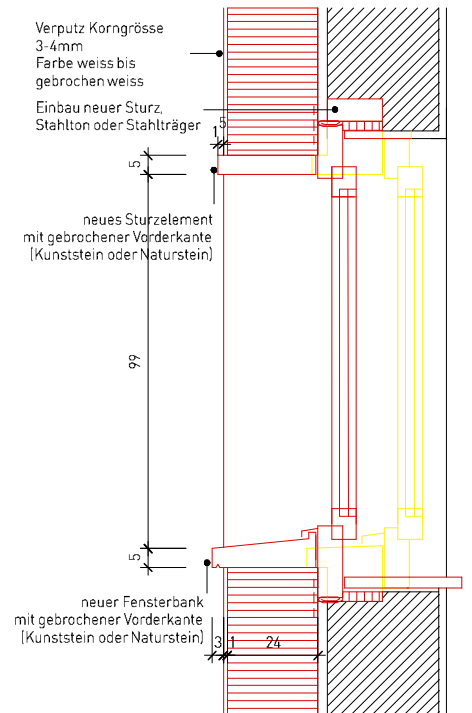

Schnitt Fenster saniert

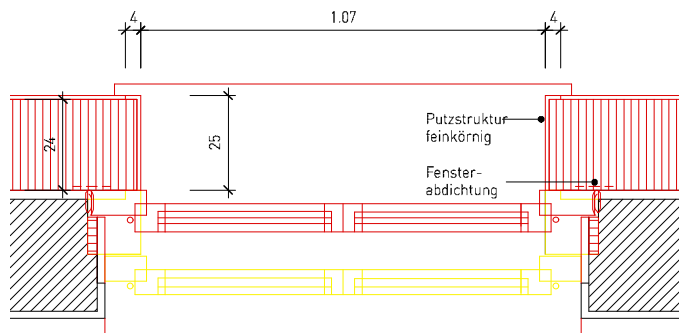

Grundriss Fenster saniert

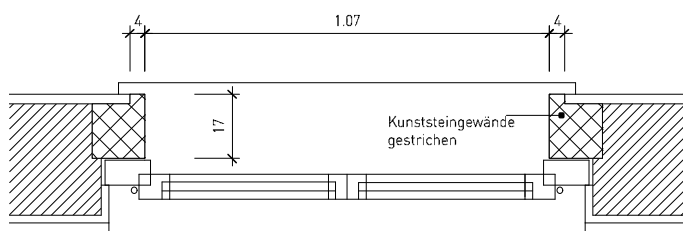

Grundriss Originalzustand

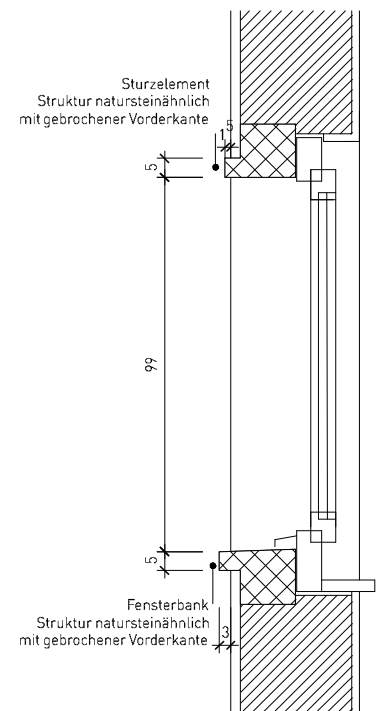

Schnitt Fenster Originalzustand

0m 0.2m 1.0m

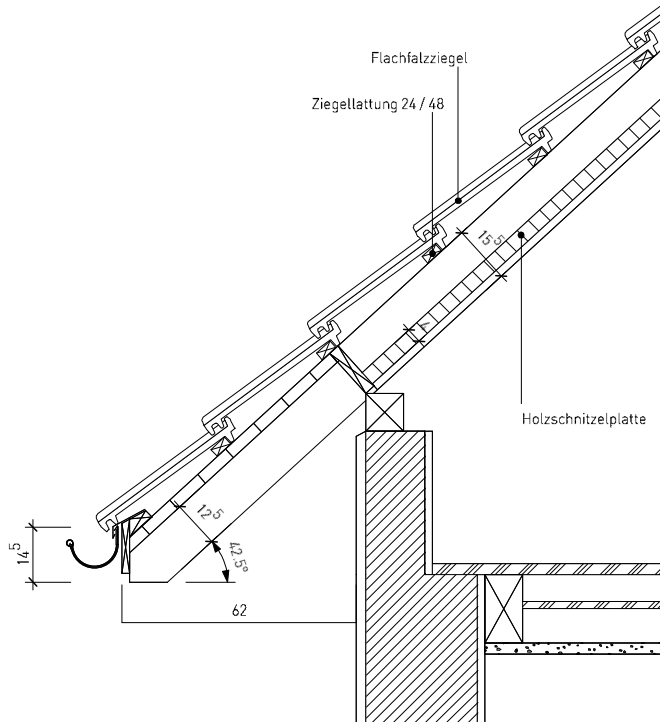

Detail Traufe Originalzustand

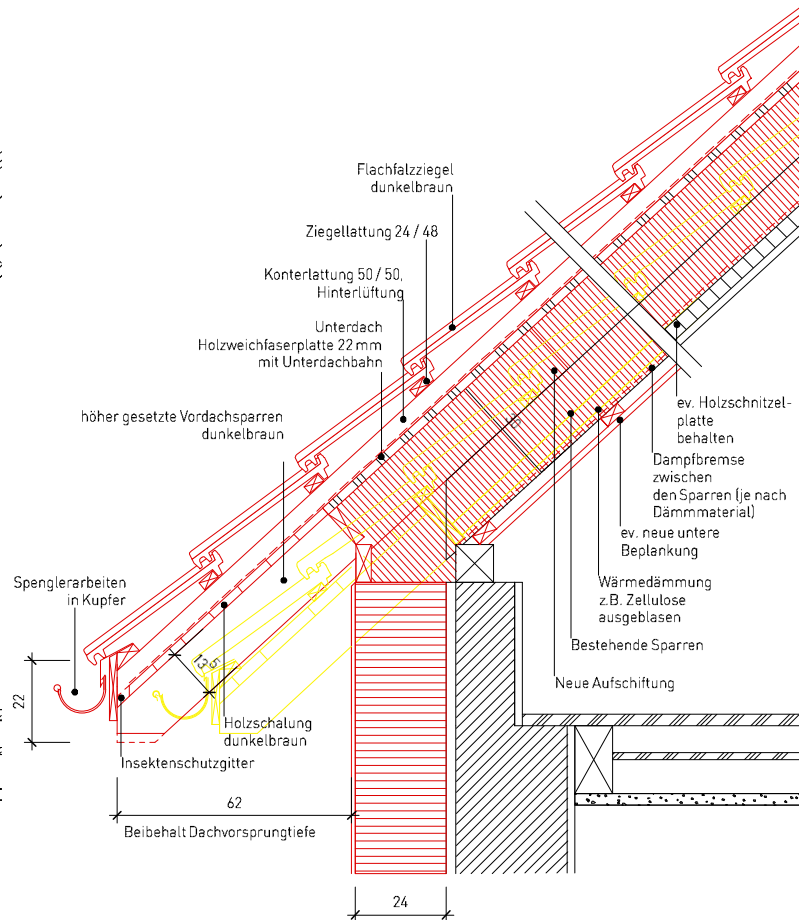

Detail Traufe saniert

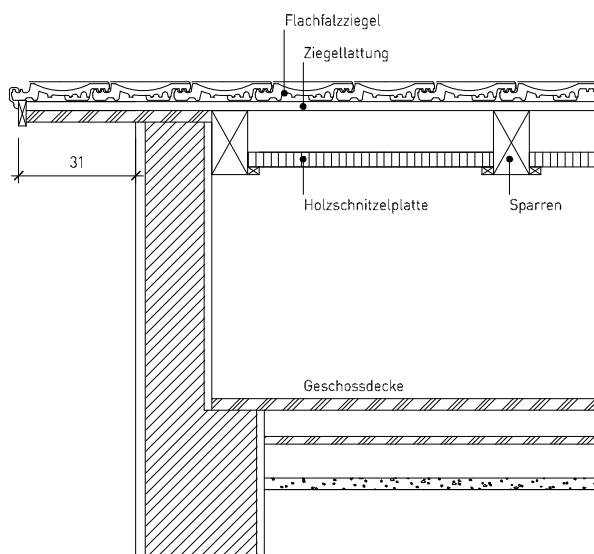

Detail Ort Originalzustand

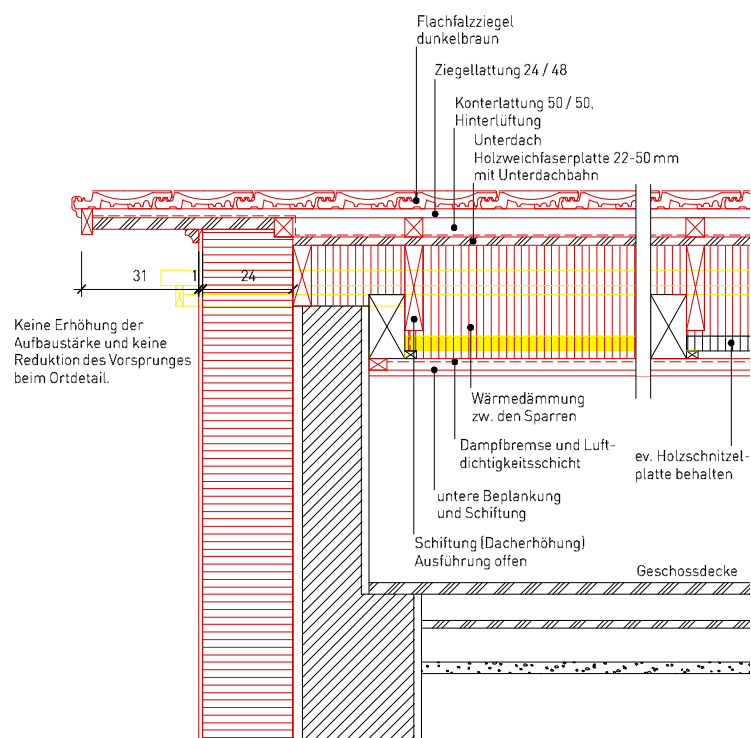

Detail Ort saniert

0m 0.5m 2.5m

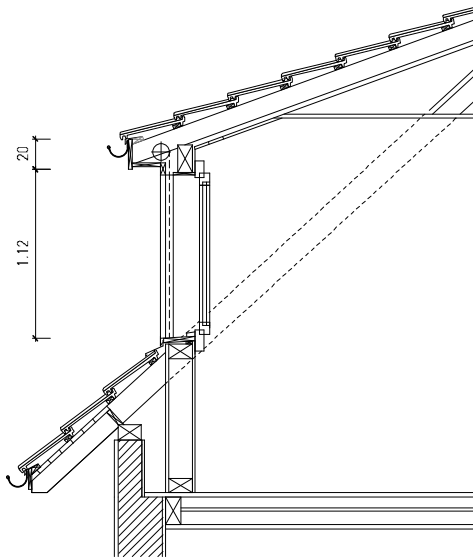

Schnitt Lukarne Originalzustand

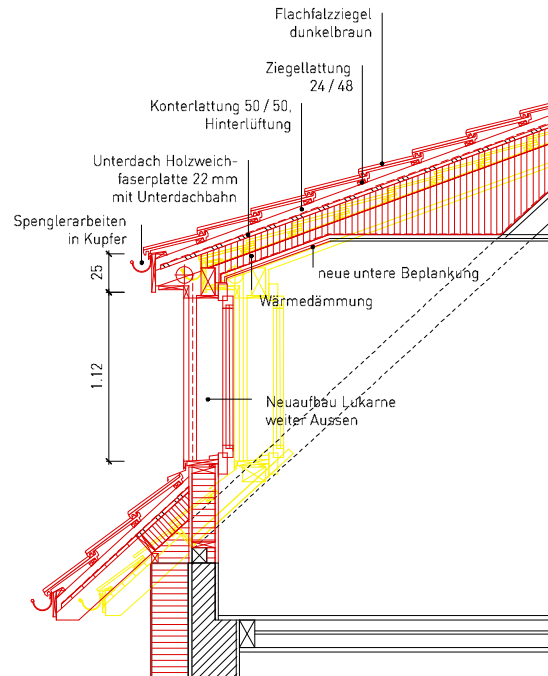

Schnitt Lukarne saniert

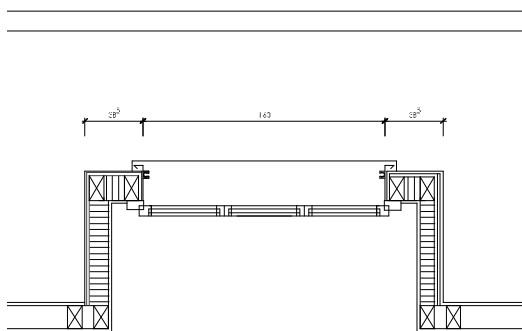

Grundriss Lukarne Originalzustand

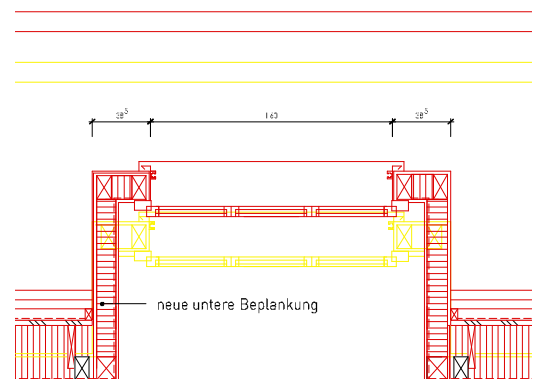

Grundriss Lukarne saniert

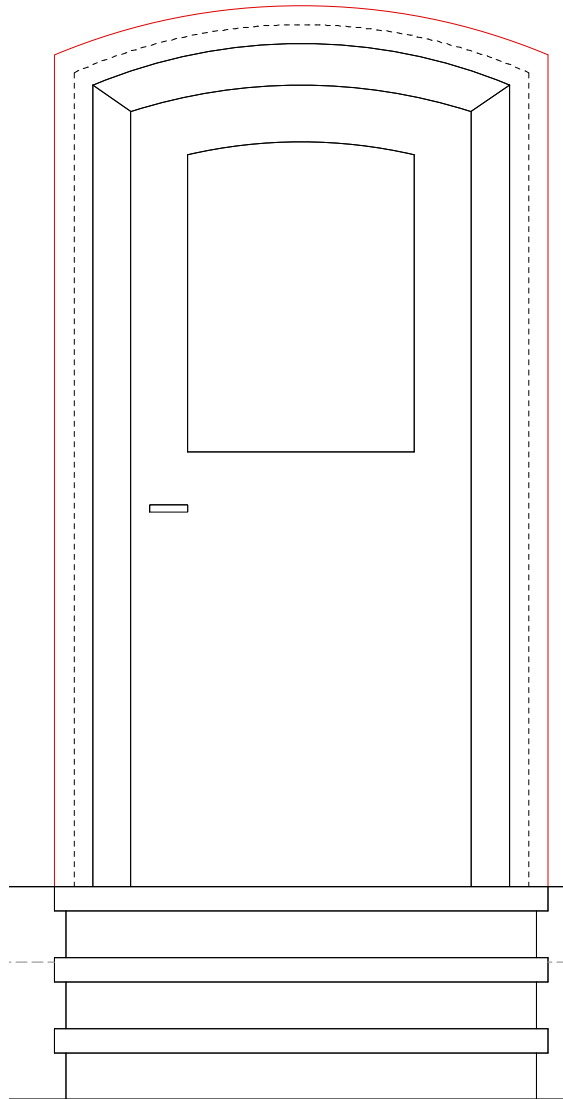

Ansicht Eingangstüre

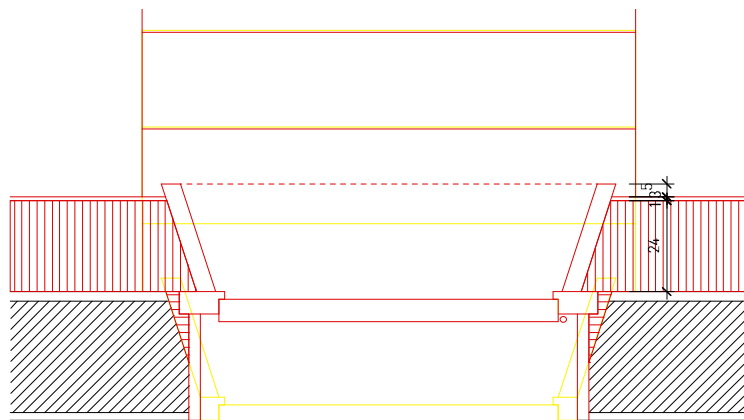

Grundriss Eingangstüre saniert

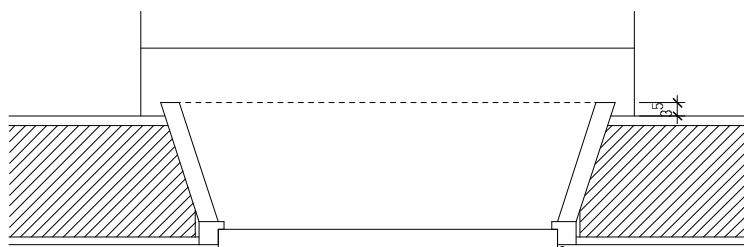

Grundriss Eingangstüre Originalzustand

0m 0.2m 1.0m

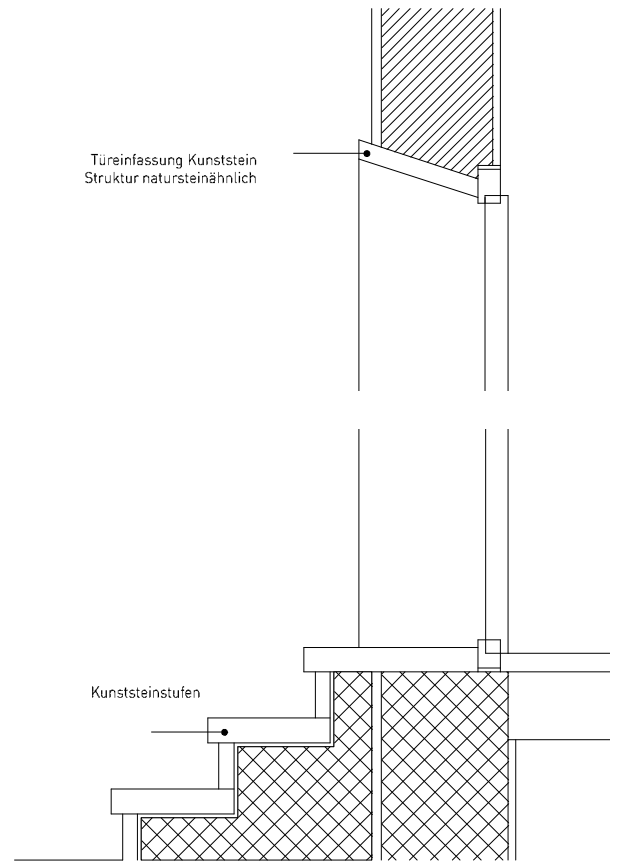

Türeinfassung Kunststein  
Struktur natursteinähnlich

Kunsteinstufen

Schnitt Eingangstüre Originalzustand

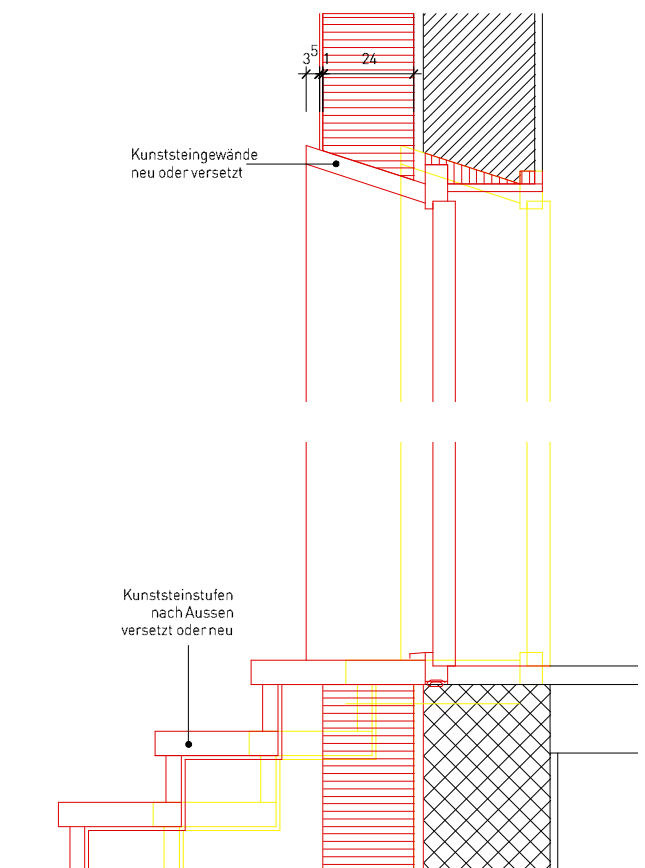

Kunsteingewände  
neu oder versetzt

Kunsteinstufen  
nach Aussen  
versetzt oder neu

Schnitt Eingangstüre saniert

0m 0.2m 1.0m

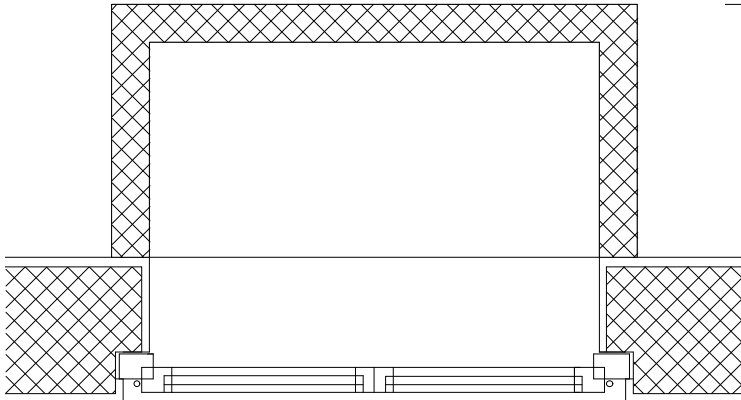

Grundriss Kellerfenster  
Originalzustand

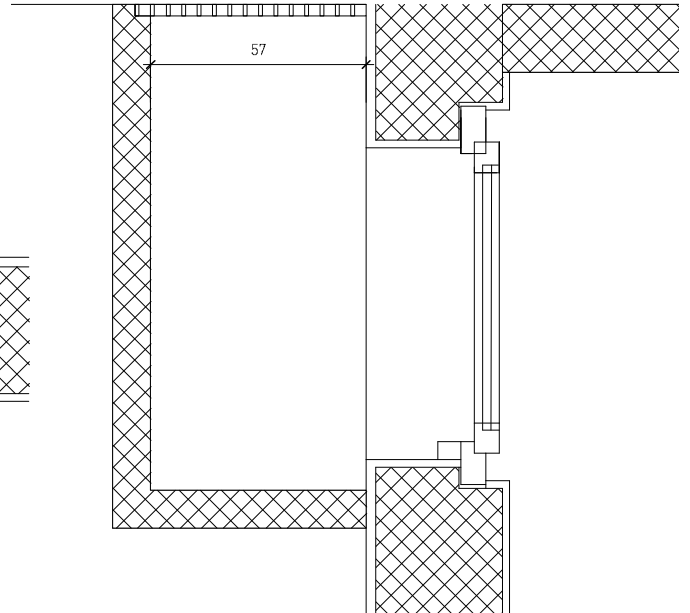

Schnitt Kellerfenster  
Originalzustand

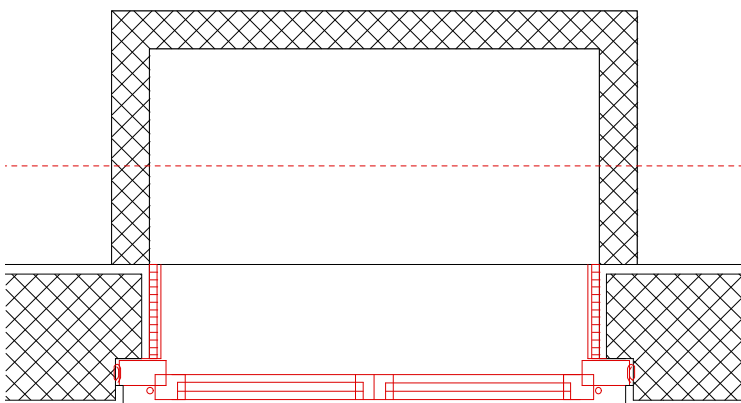

Grundriss Kellerfenster  
saniert

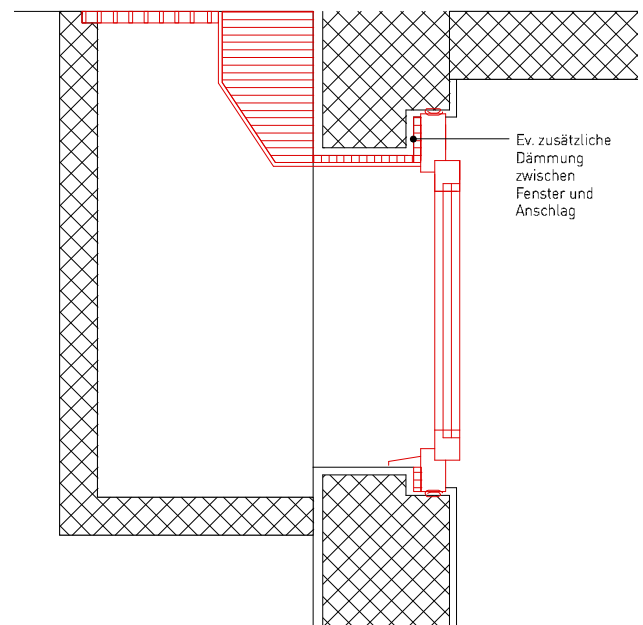

Schnitt Kellerfenster  
saniert

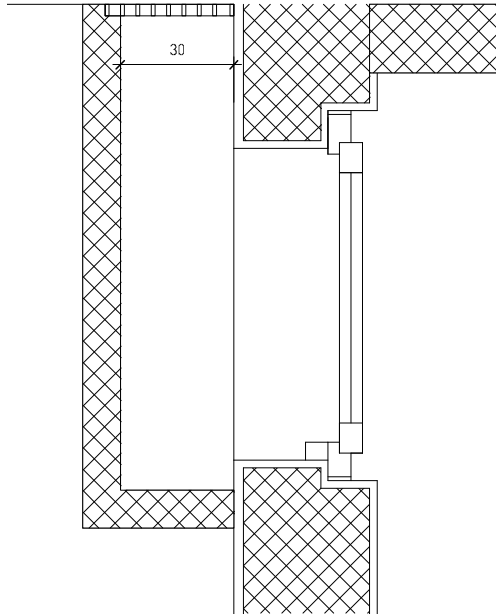
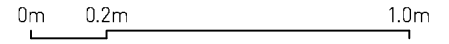

Schnitt Kellerfenster  
Originalzustand

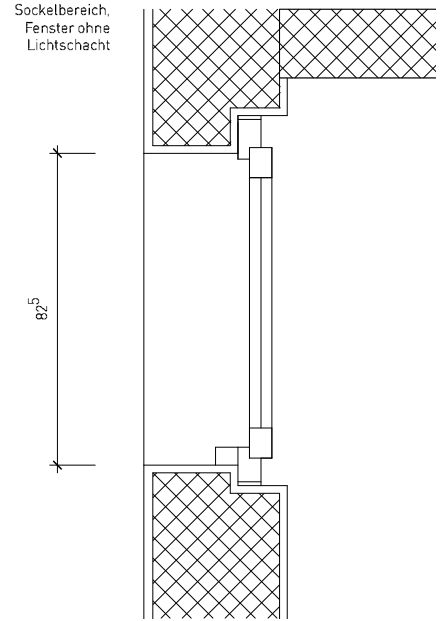

Schnitt Kellerfenster  
(ohne Lichtschacht)  
Originalzustand

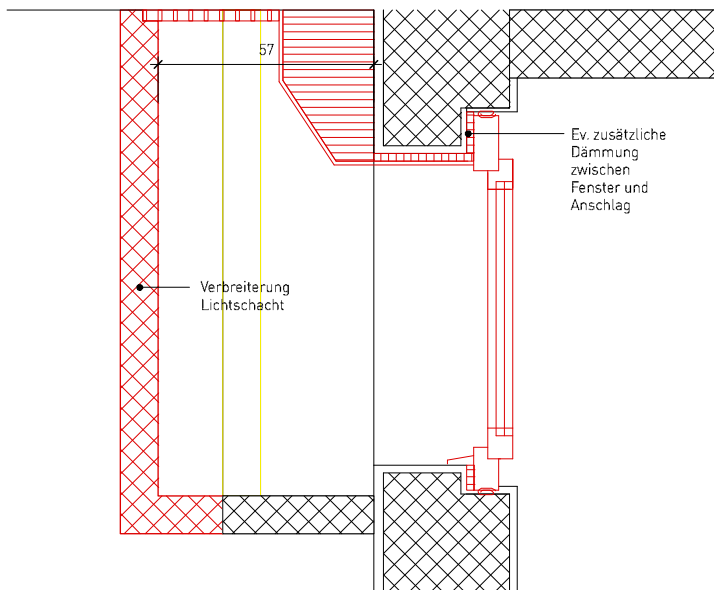

Schnitt Kellerfenster  
saniert

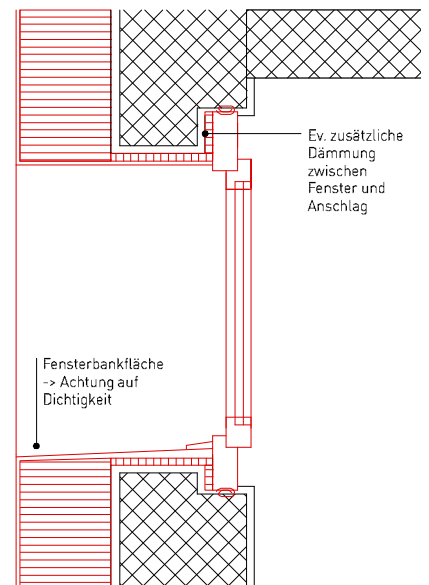

Schnitt Kellerfenster  
(ohne Lichtschacht)  
saniert

0m 0.2m 1.0m

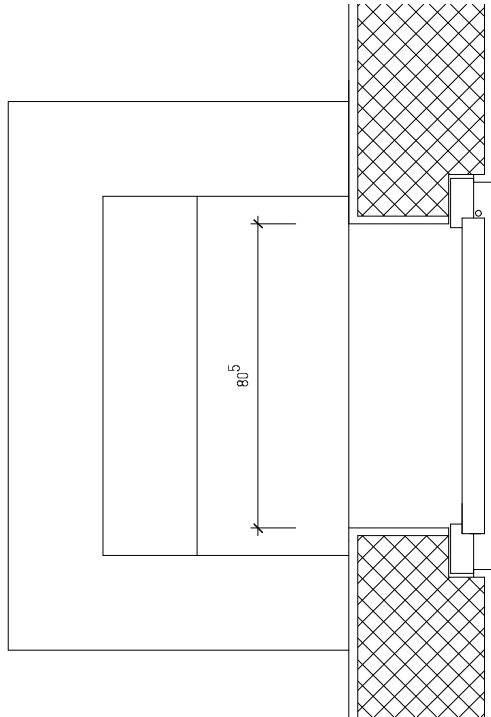

Grundriss Kellertüre Originalzustand

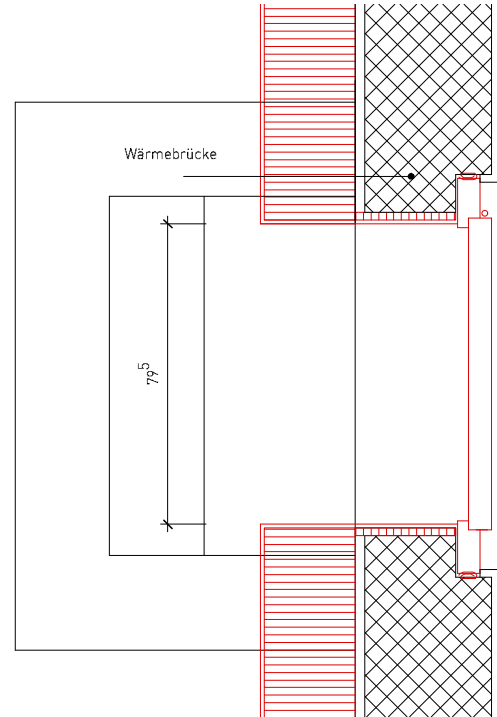

Grundriss Kellertüre saniert

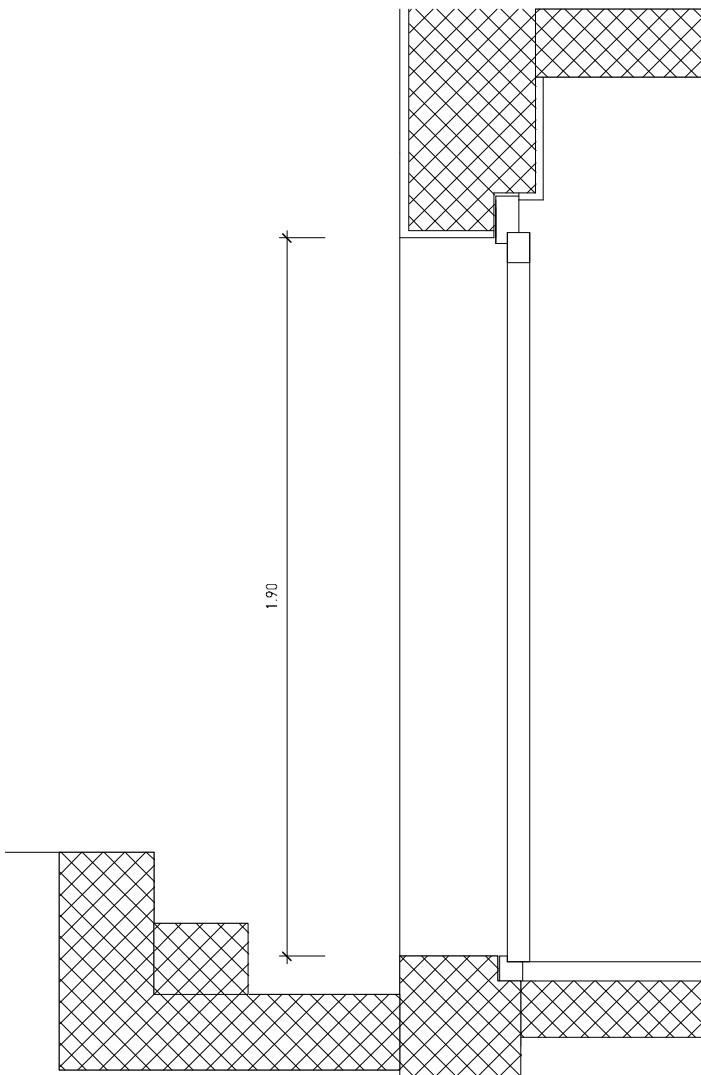

Schnitt Kellertüre Originalzustand

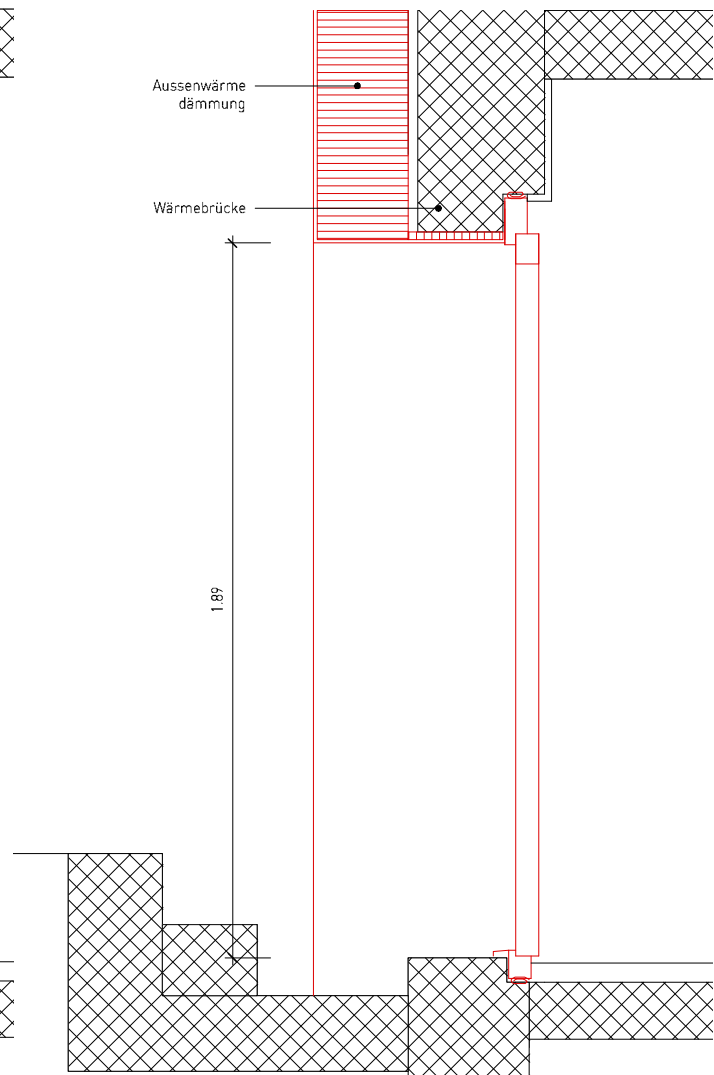

Schnitt Kellertüre saniert